

使用說明書 HOW TO USE

HITACHI
Inspire the Next

日立無霜全自動式多門電冰箱 REFRIGERATOR-FREEZER

家庭用

型號 Model R-S51AMJ



五門形式 Five doors





非常感謝您這次購買日立電冰箱。
此電冰箱是家庭使用的。請勿使用於業務用途和儲存食品以外的目的上。
請詳閱本使用說明書，以達正確使用。
使用前，請務必詳閱「安全上之注意事項」。
請妥善保管本使用說明書與保證書。

Thank you very much for purchasing a Hitachi Refrigerator.

This refrigerator is designed for home use only. Do not use this refrigerator for the business use and/or any purpose other than storing food.

Please read this operation manual carefully and ensure you use the appliance correctly. In particular, be sure to read the “Safety Suggestions” section of this operation manual before use.

Please keep this operation manual along with your guarantee card.

- **購買後，初次使用時，需要時間冷卻。**  8, 9頁
庫內冷卻可能需要約4小時至24小時以上。
- **請遵守可容納食物的高度，食品之間空開間隙儲放。**  16, 20頁
過分塞堵食物，會造成食品及袋子被挾住・門關不緊・變冷效率低・不能製冰。
- **It may take time to cool for the first time.**  Pg.36, 37
It may take more than 4 ~ 24 hours to fully cool.
- **Make sure that any food does not protrude beyond the storage height limit of each compartment, and allow clearance between each food in each compartment.**  Pg.44, 48
Otherwise, food and/or package may not be stored in each compartment properly, and as a result, the door may not be closed completely. It may cause the refrigerator to not cool sufficiently and/or not make ice.

首先 INTRODUCTION

寬廣真空室 Wide Vacuum Compartment

真空低溫冷凍變得更寬廣。可容納更多的食物，保持在最新鮮的狀態。

- 真空保存以及發揮維生素抗氧化機能，可以抑制食物氧化及變色。
- 可依照食物的不同選擇冷凍與冰溫的最適溫度。請從觸控操作面板中選擇「真空開 +1°C」或「真空開 -1°C」。

 14頁~15頁

The Vacuum Compartment is very wide and can contain plentiful foods and preserve fresh taste of the foods.

- Restricts oxidization and change in color of the foods by action of the vacuum preservation and the antioxidant vitamin.
- You can select the temperature range suited for the foodstuff. Have “真空開 +1°C (Vacuum Compartment Chiller)” or “真空冰溫 (Vacuum Compartment Subzero)” displayed on the Control Panel for operation.

 Pg.42~43



更省電 More Energy Saving

1. 霜循環冷卻

● 以霜來冷卻達到省電功能

冰箱運轉時附著在冷卻器的霜，因為會降低冷卻功效，所以必須以加熱器來加熱溶解，再排掉除霜水。

霜循環冷卻是著眼於霜的低溫，暫時停止壓縮機運轉，充分有效利用霜的低溫來達到冷藏室、蔬果保鮮室的冷卻效果。

● 有效率的各室獨立冷卻

在冷藏室、冷凍室、蔬果保鮮室等各個存放空間裝設感應器及風葉，獨立控制各室的溫度。

● 利用霜的水分來防止乾燥 (冷藏室、蔬果保鮮室)

將附著在冷卻器的霜的水分加入冷氣中，來防止食品的乾燥。

2. [eco 運轉顯示燈]

- 啟動霜循環冷卻，壓縮機暫時停止運轉或壓縮機低速運轉時則顯示亮燈，此時即是告知目前正在進行省電運轉。

若沒有顯示亮燈時

可能是放置過多的食品、冰箱門開閉次數過於頻繁、或是冰箱門開啟時間過久等原因，以致壓縮機高速運轉，eco 運轉則顯示滅燈。

→ 請盡可能冰箱開閉時間勿過久、及減少開閉次數。此外若正在進行急冷凍 / 急冷藏運轉時，因必須在短時間內啟動壓縮機來將冰箱內的溫度降低，所以 eco 運轉則顯示滅燈。  30頁

1. Frost Recycle Cooling

● Energy saving by effectively utilizing frost

In the past, frost adhered to the radiator was melted by a heater and discharged as defrosted water because it lowers cooling efficiency.

Frost Recycle Cooling utilizes the cold of frost. The compressor operation is stopped and Refrigerator Compartment /Vegetable Compartment are cooled by utilizing the cold of frost.

● Each compartment is independently cooled effectively

A sensor and a flap are installed in each compartment of Refrigerator Compartment, Freezer Compartment and Vegetable Compartment, and the temperature of each compartment is controlled independently.

● Prevents food from drying out, utilizing the moisture of frost (Refrigerator Compartment/Vegetable Compartment)

In addition to the cold of frost, the moisture of frost on the radiator helps the food from drying out.

2. [“eco” operation indicator lamp]

- This indicator lamp will be illuminated to indicate the energy-saving operation when the compressor is stopped during the Frost Recycle Cooling or while the compressor operates at low speed.

When “eco” indicator lamp is not illuminated

When too many foods are stored inside or the door are opened or closed too frequently or the door is left open for a long time, the compressor will operate on high speed. So, “eco” operation indicator lamp will not be illuminated.

→ Please open or close the door quickly or minimize the number of times of opening and closing the door. “eco” operation indicator lamp will not be also illuminated on during the quick freezing/cooling operation because the inside of the refrigerator is cooled quickly.  Pg. 58

目錄

使用之前

- 安全上的注意事項 4
- 使用之前 8
 - 設置場所 8
 - 在周圍請空開充分的散熱空間 8
 - 箱門的平衡調整 8
 - 關於電源插頭及接地 9
 - 放入食品 9
- 操作面板 / 各部分的名稱 / 儲存室 10
 - 冷藏室門操作面板 10
 - 各室的名稱 11
 - 適於儲存的食物 11

平常的使用方式

- 冷藏室 12
 - 調節冷藏室的溫度 12
 - 快速冷藏 (需快速冷卻的時候) 12
 - 置蛋盒 (可放入雞蛋等食品, 保存在冷藏室) 13
 - 層架及置物架可調整 13
- 真空室 14
 - 使用準備 14
 - 關閉真空室門 14
 - 日常保養清潔的方式 15
 - 取下真空密封墊, 保養清潔時 15
- 冷凍室 16
 - 上層冷凍室 / 下層冷凍室 16
 - 可容納食品的高度 16
 - 調節冷凍室的溫度 17
 - 急速冷凍 17
- 製冰室 (自動製冰機) 18
 - 製冰方法 18
 - 切換自動製冰機的設定內容 19
 - 用於急需製冰時 (急速製冰) 19
 - 製冰時間與製冰能力 19
- 蔬果保鮮室 20
 - 下段置物盒 · 寬廣上段置物盒 20

保養方法

- 保養方法 / 冰箱內 · 冰箱外的保養 21
 - 發現髒時 21
 - 電源插頭 21
 - 冰箱內 · 冰箱外的清掃 21
- 卸除組件的方法 22
- 自動製冰機的保養 23
 - 製冰機清潔 23
 - 給水槽 / 淨水濾片 23
 - 製冰盤 23

遇到問題時

- 遇到問題時 24
 - 購買後, 初次使用時常有的疑問 24
 - 操作面板沒有反應 24
 - 自動製冰不正常 24
 - 不冷 25
 - 結霜 · 結露 25
 - 太冷 25
 - 聲音不對 26
 - 冰箱發熱 26
 - 真空冷凍上的問題 27
 - 有異味 28
 - 箱門高低不平衡以及歪斜 28
 - 其他 28
- 這種情況下 / 另購零件 29
- [eco 運轉顯示燈] / 箱門警報器 / 操作面板鎖定 30
- 有關碳氫化合物的冰箱 / 規格 / 可容納的食品重量 ... 59

安全上的注意事項

請務必遵守

為了防止危害到使用者或其他人及造成財務上的損失，請務必遵守以下事項。

■ 以下將以標示方式，區分及說明忽視標示內容而誤用時所產生的危害與損失程度。

■ 以下將以圖示標示方式，區分及說明應遵守內容的種類。(以下為圖示標示例)



警告

此標示欄表示「可能會造成死亡或身負重傷之預測內容」。



注意

此標示欄表示「可能會發生受傷或財務損失之預測內容」。



此圖示標示為「禁止」內容(請勿執行之事項)。



此圖示標示為「強制」內容(請務必執行之事項)。

警告

安裝時

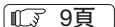

連接接地線

- 請確實實施接地。避免因故障·漏電等因素而發生觸電。
- 請務必委託經銷商執行接地工程。  9頁



禁止淋濕

- 請勿設置於潮濕或會被水淋到的場所。
- 避免因電氣絕緣不良而引起觸電·火災的危險。



- 針對地震等天然災害做好防止翻倒處置。
- 避免因翻倒而受傷。  9頁



電源及電源電線



禁止

- 使用時請勿高於插座或配線器具的額定電流。請勿使用交流額定電壓以外的電源。
- 若與其他電器插頭併用，或使用三面插座等，會因異常發熱而造成火災的危險。
- 請單獨使用額定電流 15A 以上的插座。



禁止

- 請勿讓電線·插頭破損。

請勿讓電線受損·加工·接近發熱器具·勉強彎曲·扭曲·拉扯·乘載重物·讓冰箱壓住電線或捆綁電線。

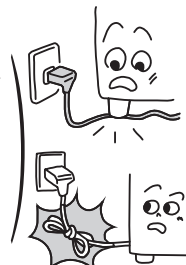

在已受損的狀態下使用時，會引發觸電·短路·火災的危險。

- 電源線損壞時，須由製造廠商或其服務處或具有相關資格的人員加以更換以避免危險。



- 將插頭的電線向下，將插頭確實插入插座內。
- 如果插頭方向相反插入，會給電線增加負擔，成為短路·觸電·起火的原因。
- 如果插頭插得不夠完全，也將會成為因觸電，發熱而導致火災的原因。

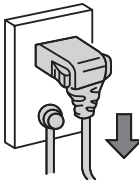

禁止濕手

- 請勿用潮濕的手，拔除插頭。
- 發生觸電的原因。



- 請定期清除插頭上的灰塵。當插頭堆積灰塵時會因濕氣而造成絕緣不良，進而引起火災。
- 請拔除插頭再用乾布擦拭乾淨。



- 進行冰箱保養，請務必拔掉插頭。
- 有觸電或受傷的危險。
- 請將插頭確實的從插座內拔出。

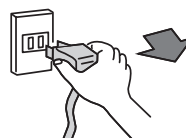

警告

在一般使用的情況下



禁止淋濕

- 請勿用水淋濕主體與箱內。
 - 避免因電氣絕緣不足而引起觸電·火災。



禁止

- 請勿放入容易引火的物品。
 - 揮發油·乙醚·LP 瓦斯·稀釋液·黏著劑會發生引爆的危險。



禁止淋濕

- 請勿將含水容器放在冰箱上。
 - 翻倒的水會造成電氣組件絕緣不良而發生漏電·火災·觸電的危險。



禁止

- 在附近請勿使用可燃性噴霧用品。
 - 避免因箱門開關等電氣接點引起的火花引發火災。



禁止

- 請勿在冰箱上放置物品。
 - 避免因開閉箱門，造成物品掉落而受傷。



禁止

- 請勿用來保存藥品或學術試樣。
 - 必須嚴格管理的物品，不可保存於家庭用冰箱內。



禁止接觸

- 請勿手觸自動製冰機的機械部位。
 - 製冰盤旋轉時，手恐怕會受傷。

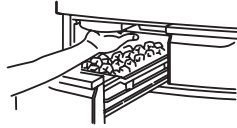

禁止

- 請勿懸在箱門上嬉戲，或踏在收納盒上。
 - 避免因翻倒，夾到手指而受傷。



- 請注意不要讓孩子們玩耍。



禁止

- 請不要拆卸冰箱內燈的蓋子。
 - 燈泡損壞時，須由製造廠商或其服務處或具有相關資格的人員加以更換以避免危險。

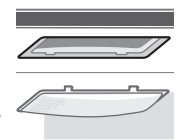

警告

關於冷媒（由於這是一種可燃性的氣體，請注意以下的事項。）



禁止

- 不可以螺絲等銳利物品刮傷冰箱本體。
由於使用可燃性的冷媒，當冷媒從冰箱內壁的配管外洩，會有起火、爆炸的危險。

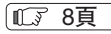

- 安裝的時候，在周圍要離開一些間隙，確保有足夠的散熱空間。  8頁
若冷媒外洩的情況持續，會有起火、爆炸的危險。

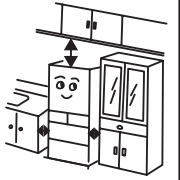

- 請勿損傷冰箱的冷卻管路。
冷媒配管損壞時，請將冰箱遠離火源並避免使用電器用品。

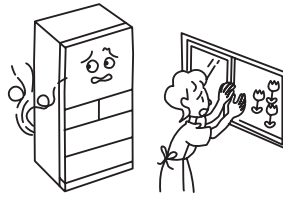

- 如需進行廢棄處理時，請聯絡經銷商或環保署資源回收中心專線 (0800-085-717)，交給他們進行專業處理。
若冷媒外洩會有起火、爆炸的危險。



禁止

- 除廠商建議方法外，不得使用機械工具或其它工具來加速除霜的過程。

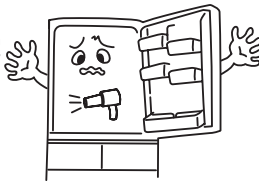

禁止

- 請勿在冰箱內部使用電器用品。
· 如冷媒外洩，電氣接點所產生的火花，會有起火、爆炸的危險。

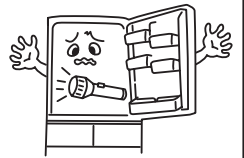

萬一有下列情形



- 當產品異常或故障時，請拔掉插頭停止運轉。
有觸電或受傷的危險。
· 請務必在拔除插頭時握住插頭。

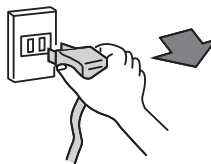

禁止分解

- 請勿自行分解、修理、改造。
避免發生火災，異常動作而受傷。
· 需分解、維修時，請洽經銷代理商。



- 可燃性氣體外漏時，勿接觸冰箱，請立即開啟窗戶進行換氣。
· 避免因箱門開關等電氣接點的火花，而發生引爆、火災、燙傷等危險。



廢棄處理時



- 在等待廢棄物再利用保管之際，因有幼兒被誤困在箱內之虞，請將門墊拆下來。

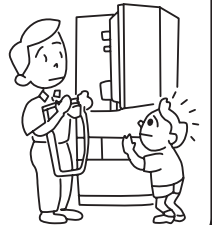

⚠ 注意

移動・搬運時



禁止

- 請勿在容易刮傷的地板上使用冰箱滑輪。
避免因滑輪而刮傷地板。
- 請在容易刮傷的地板上鋪上保護板。

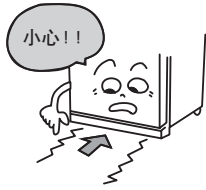

- 搬運時，請用手持手把搬運。
倘若沒有手持把手，可能會因手滑而受傷。
- 請僱用 2 人以上手持手把搬運。
- 搬運時請如圖示般將箱門朝上。
- 請不要用起重機等吊起把手。



在一般使用的情況下



禁止

- 請勿在超大瓶飲料的縫隙間再塞入其他瓶罐。
● 勉強放入超大瓶飲料瓶後，在開閉箱門時，可能會因掉落而受傷。



禁止

- 請勿讓食品凸出層架。
● 避免因鉤到瓶罐後掉落而受傷。

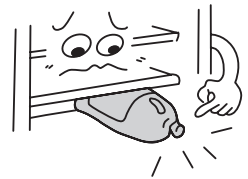

禁止

- 請勿將瓶子放在冷凍室內。
● 內容物結凍會使瓶子破裂，容易受傷。

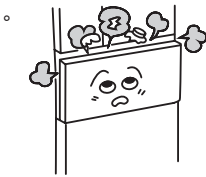

- 同時開啟二個以上的箱門時，或者其他人也在碰觸冰箱時，請確認手指是否會被冰箱門夾住。
● 避免手指被門與門之間的縫隙所夾傷。



禁止

- 關抽屜型的箱門時，請勿手持上方推進。
● 按住門上方關抽屜會夾住手指容易受傷。

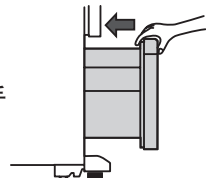

禁止

- 請勿用潮濕的手碰觸冷凍室內的食品或容器。
● 避免凍傷。(尤其是金屬製品)



禁止

- 開啟最底層的箱門時，請勿讓腳靠近冰箱。
● 避免在開啟箱門時，碰觸到腳底而受傷。



禁止

- 請勿食用有異味、已變色的食品。
● 避免因食品腐敗而引發疾病。



禁止

- 手腳不要放進冰箱的底部。
清理時將手伸入冰箱底下時，可能會被鐵板割傷。

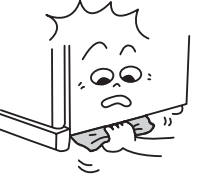

使用之前

1 設置場所

- 堅固・水平的地板
地毯・榻榻米（日式草蓆地板）・木板地・塑膠地板等恐怕會有變形・變色的可能，請墊（1cm厚）的板。
- 避免陽光直射和高溫
- 不潮濕・空氣流通的地方
這些可防止冷卻功率下降・避免電費增加。而且可抑止變色以及生鏽。

2 在周圍請空開充分的散熱空間

- 為了保持良好冷卻效率，在周圍請空開充分的散熱空間。
- 本體側面的中央部分是比所表示的尺寸稍大。
設置時請確保充裕的空間。
- 背面可靠牆設置。若有振動音或是不願讓牆壁弄髒及變色的話，請空開一些間隙。

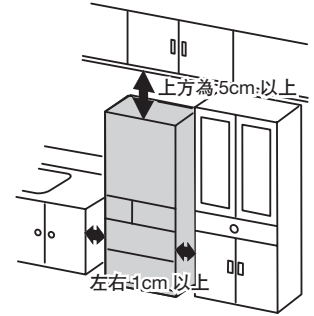

3 箱門的平衡調整

- 設置的地方不平，地板太軟，加上食物的重量，冰箱腳會下沉，箱門會稍有歪斜。
→ 機能上沒有問題，如介意請按如下的步驟進行平衡調整。
進行左右水平調整，並使冰箱的前側稍微高一點可方便關門以避免門沒關好。

1 手持腳座護蓋的兩端，用力拉向身前卸下。

2 旋轉調整腳，把腳降低到地面固定。（左右兩個地方）

3 旋轉調整腳來調整，直到電冰箱的門平衡。

- 調整腳的旋轉量是，每旋轉1圈相當於箱門的高低差距1mm。
- 調整以後，因為電冰箱本體與地板適應要花幾天時間，已經調整過的箱門會出現高低不平。箱門高低不平衡的時候，請再次按步驟進行平衡調整。
- 歪斜還是沒有改善的話，請使用另購部件：「箱門調整墊」（產品型號：R-Y6000500）。詳細內容請洽詢經銷店。

4 將腳座護蓋的卡榫（左右）插入安裝孔內安裝。

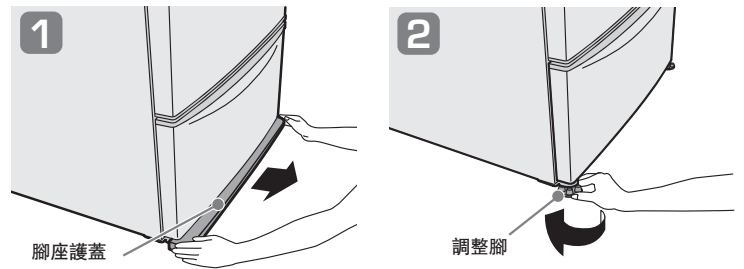

■ 左側下歪

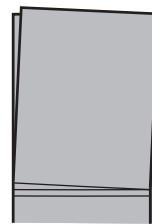

■ 右側下歪

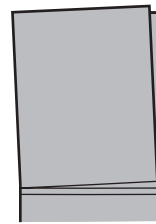

■ 調整腳難以旋轉時
請使用螺絲起子等推轉。

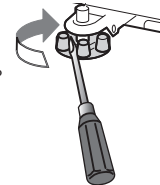

4 關於電源插頭及接地

- 設置後直接就可插上電源插頭。
- 請用獨立的插座。(電源 110V · 額定電流 15A 以上)

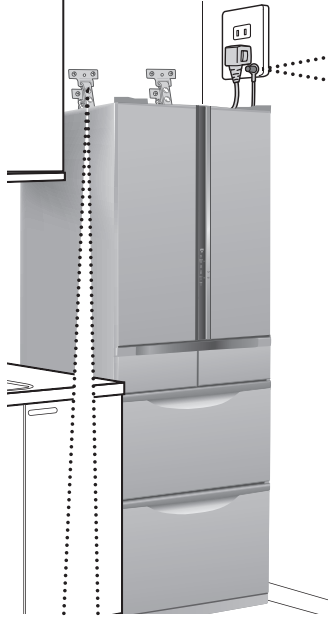

為了防止萬一觸電，建議實施接地。

- 如設置地方特別潮濕，請與經銷店洽商，接地線或安裝漏電開關。
- 另購部件：「地線 (2.5m)」(產品型號 .NW-60R6 052)

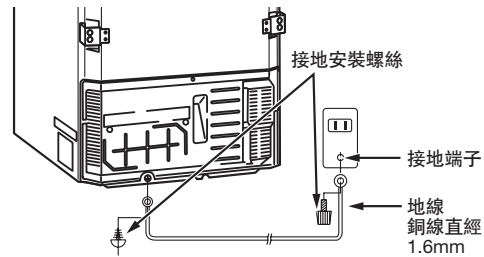

不可接地線的地方

- 自來水管 (有觸電的危險)
- 煤氣管 (有爆炸的危險)
- 電話線及避雷針的地線 (打雷時會發生危險)

對於防備地震

- 建議使用兩條「冰箱防倒安全帶」，固定在堅固的牆壁或柱子上。
- 另購部件：「冰箱防倒安全帶」(產品型號 .R-826CV 300：1 條裝) 詳細內容請洽詢經銷店。

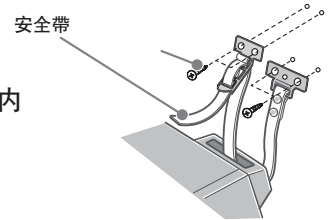

5 放入食品

- 冰淇淋、未冷卻的食品、容易受傷的食品等，在冰箱尚未充分冷卻前請勿放入冰箱。
- 根據冰箱周圍溫度、食品的存放方式不同，冰箱內充分冷卻需要 4 小時，也有可能需要 24 小時以上。
- 初次使用自動製冰時，請操作自動製冰機的清潔「製冰機清潔」。[☞ 23頁](#)
- 自動進行連續的製冰運轉是必須在冰箱內充分冷卻之後才能開始。(初次使用時，最初的結冰可能需要花 24 小時以上。)
- 為了盡快冷卻，請盡量減少冰箱門開閉的次數。
- 食品儲放時請保留間隙。
- 開始使用時，可能有塑膠的氣味。為了不讓氣味悶在室內，請讓房間內保持通風良好。塑膠氣味自然會消失。
- 魚類、肉類或乾燥後會變質的食品、或是味道強烈的食品，請用保鮮膜包覆或是放在密閉容器內之後再放到冰箱內保存。

通知事項

- 請勿將背面的標貼撕掉。標貼是為了保持性能與安全性。
- 請勿將側面下部的塑膠零件與標籤撕下。

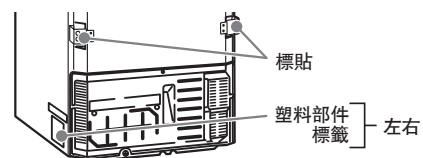

※ 若有硫化氫氣體噴出的溫泉地區等設置時，可能有必要進行配管的防銹處理，請預先與經銷店洽商。另外，由於煤氣受造成的故障是不屬於保證項目以內。

操作面板 / 各部分的名稱 / 儲存室

冷藏室門操作面板

- 操作面板的圖像（是顯示部分全部亮燈時的影像。實際上，只有選擇的文字才亮燈。）
操作結束後，經過約 2 分鐘文字顯示燈則熄滅。但是急冷運轉的顯示以及 eco 運轉顯示燈則亮燈。
要確認設定時請按任何一個按鍵。顯示燈則再度亮燈。



方便的機能

真空室	按真空チルド鍵選擇「真空開 +1°C」「真空開 -1°C」「真空開 -1°C」(P.14頁) 出貨時，設定為「真空開 -1°C」。
急冷功能	按急冷鍵選擇「急冷凍」「急冷藏」「急冷凍 急冷藏 (同時)」
急速冷凍	強烈冷卻冷凍室。需儘快冷凍的時候。(P.17頁)
快速冷藏	強烈冷卻冷藏室。需快速冷卻食品及飲料的時候。(P.12頁)
急速冷凍・快速冷藏 (同時)	冷凍室與冷藏室同時強烈冷卻。比單獨設定為「急冷凍」「急冷藏」的時候效果較弱。
製冰功能	按製冰鍵選擇冰的大小「標準」「大顆」。(P.19頁) 不用自動製冰時，選擇「停止」。
製冰機清潔	按住製冰鍵 5 秒以上，可自動清洗製冰盤和給水路。(P.23頁)
eco 運轉顯示	正告知冰箱的運轉情形。 也可以將顯示燈熄滅。(P.30頁)
確認	「確認」閃爍時是提示有異常。(P.29頁)
按鍵鎖	為了防止操作面板的操作錯誤，請按住 鍵 3 秒以上，使  (操作部鎖定) 顯示亮燈 (P.30頁)

溫度調節

冷藏室	按冷藏鍵設定 (P.12頁) 平常請設定在「中」的位置。
冷凍室	按冷凍鍵設定 (P.17頁) 平常請設定在「中」的位置。

通知事項

- 請在所有的門都關閉的狀態進行操作。為了防止冷藏室門開放中的操作錯誤，即使顯示文字亮燈中，按冷藏室門的操作面板也不會有反應。
- 箱門打開時間長達 1 分中以上，冷藏室門操作面板的文字顯示會閃爍 (冰箱門警示器)。(P.30頁)

各室的名稱

冷藏室

(約 2°C~6°C)

12頁 冷藏食品

箱門置物架附近溫度會稍高。

製冰室

(約 -20°C~-18°C)

18頁

保存自動製冰機所製造的冰塊。

蔬果保鮮室

(約 3°C~7°C)

20頁

蔬菜、水果、飲料

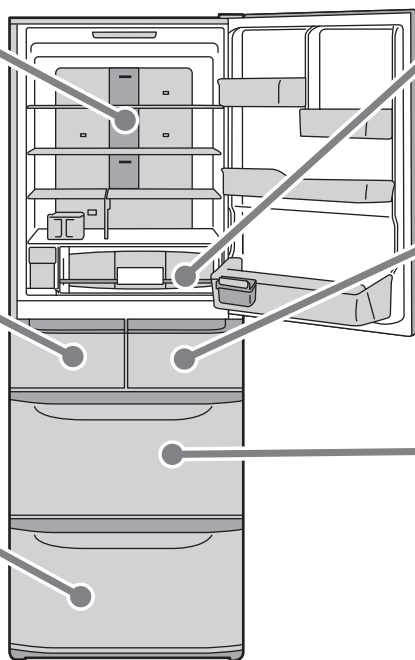

真空室

(約 -1°C~約 1°C)

14頁

保存的食品請參照下列一覽

上層冷凍室

(約 -20°C~-18°C)

16頁

儲存冷凍食品、冰淇淋及乾糧。

下層冷凍室

(約 -20°C~-18°C)

16頁

儲存冷凍食品、冰淇淋及乾糧。

低溫冷凍 17頁

(約 -23°C ~ -20°C)

以比平常溫度低的低溫保存。

適於儲存的食物

真空開 +1°C

利用真空及防止氧化維生素來保存蔬菜沙拉、乳類製品、肉類、魚類等食品，可以防止食品中富含的營養素氧化。

●蔬菜、水果



蔬菜沙拉、燈籠椒、蘋果、柳橙、奇異果等。

●其他

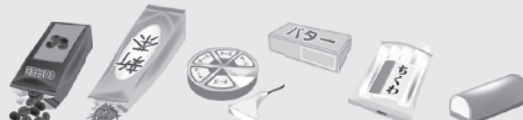

咖啡豆、茶葉、乳製品、醬料等。

因為比真空冷凍的溫度還低，適合保存肉類、魚類等食品。放入其他食品有可能因低溫而結凍或變質。建議此處只用來保存肉類、魚類食品。

●肉類、加工肉



牛肉、豬肉、雞肉、火腿片、香腸等。

●魚類、海鮮類



竹莢魚、沙丁魚、鯖魚、魚蛋等。

真空開 (冰溫)
(約 -1°C)

關閉真空功能。建議存放需裝在「密封袋」、「密封容器」的食物。因為是冰溫室，食物有可能因低溫而凍結。

儲存時需要注意的食品與容器

●密封袋包裝食品

密封袋在儲存時可能會膨脹而擠壓到其他食品。



維也納香腸、乳酪片等。

注意

●塑膠密封容器

塑膠密封容器的蓋子在儲存時可能會鬆開或脫離原來的位置。取出時請注意。



注意

不適於儲存的食物

●不耐低溫的蔬果

低溫可能會使得蔬菜表面變質。

●儲放肉、魚、肉類及魚類加工食品以外的食物時，請勿設定為「真空開 -1°C」、「真空開 -1°C」。蔬菜或豆腐等水分多的食品會有凍結的可能。



茄子

小黃瓜

周圍溫度為 30°C，此溫度是在沒有放入食物，關上冰箱門時的標準溫度。夜間或不在家等情形，長期沒有開閉冰箱門取出放入食物，因壓縮機低速運轉，可能造成較大的震動。

冷藏室

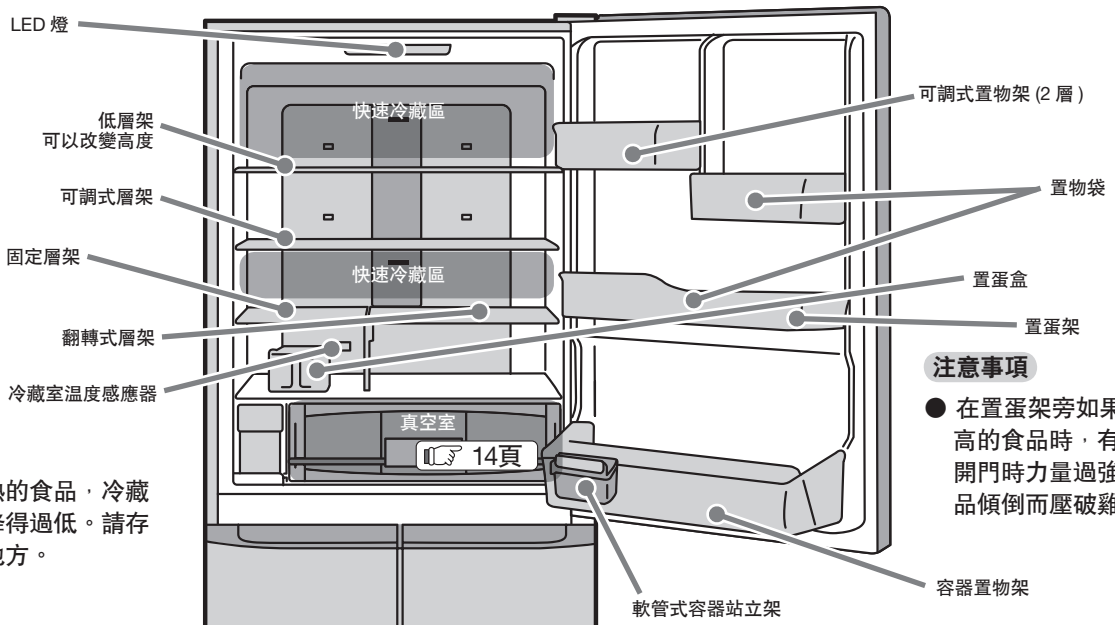

注意事項

- 在附近放熱的食品，冷藏室溫度會降得過低。請存放在別的地方。

注意事項

- 在置蛋架旁如果放置較高的食品時，有可能因為開門時力量過強，以致食品傾倒而壓破雞蛋。

❑ 冷氣吹出口

注意事項

- 因為溫度變低，請勿放置水分較多的食品或罐裝飲料。有可能造成食品凍結或破損。

調節冷藏室的溫度

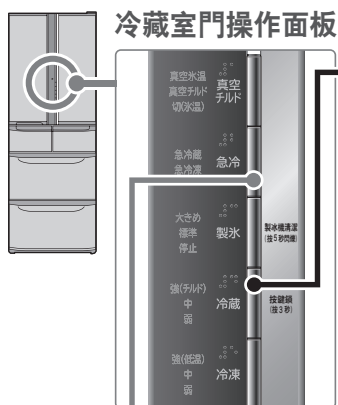

冷藏室溫度的調節

按 冷藏鍵調節。

是在環境溫度 30°C、不放食物、關著門、安定時的標準值。

強 (冷凍)	比“中”低約 1 ~ 3°C
中	約 2 ~ 6°C
弱	比“中”高約 1 ~ 3°C

- 通常請使用“中”的位置。溫度因使用條件而有所變動。
- 設定改為“強”或“弱”時，真空室的溫度也會改變。
- 箱門層架比左表的溫度略高。

- 通知事項**
- 操作結束後，經過約 2 分鐘文字顯示燈則熄滅。但是急冷運轉的顯示以及 eco 運轉顯示燈則亮燈。 (P. 10)
 - 操作部分的詳細使用方式 (P. 10)
 - 調節更細微的溫度時 (P. 29)

快速冷藏 (需快速冷卻的時候)

1 在快速冷藏隔層放食物

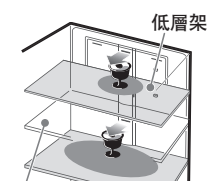

- 放在中央的真頭部分可較快冷卻。(冷氣吹出口前面)
- 水分多的食品及罐頭飲料請離開背面存放或是移放到下層。因會有凍結、破裂的危險。

通知事項

- 與急速冷凍機能同時使用的時候，依據冰箱的運轉狀態，效果會有變弱的可能。 (P. 17)

2 按急冷鍵使「急冷藏」的顯示亮燈 ※



※ 設定為「急冷藏」之後，「急冷藏」以的顯示燈經過約 2 分鐘即熄滅。

3 約 45 分鐘「急冷藏運轉」自動終了，「急冷藏」顯示自動熄滅



按鍵滅燈

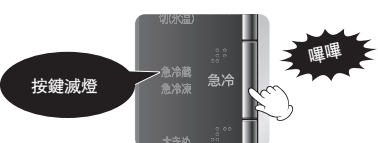

置蛋盒 (可放入雞蛋等食品，保存在冷藏室)

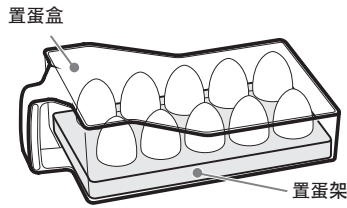

可以存放 10 個雞蛋。
雞蛋盒可以直接放入。

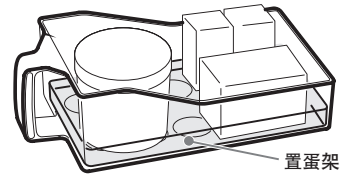

可將置蛋架翻轉，背面的盒架可以用來放置小型的食品。

注意事項

- 操作時請緊握手把。
- 因食物可能會落下，請勿將食品重疊存放。
- 因食物可能會傾倒，請勿放入過高的食物。
- 請不要用此容器來製冰。
- 置蛋盒請勿放入下移式便利盒內。

層架及置物架可調整

層架及置物架可配合食品大小進行調整。調整層架時，請先將儲藏的食品移出。

■ 可調式層架 · 低層架

- 1 從裡面把層架稍微抬高，往前拉出後就可取出。
- 2 按照所需的高度，把層架插放到最裏面之後，稍微提高層架的內側再推進去。(將層架的鉤子扣掛在最裏面的部位上)

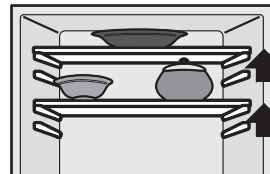
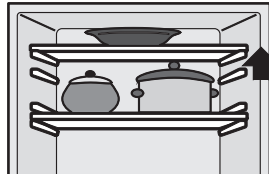
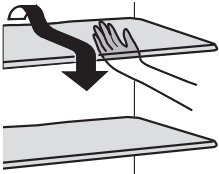

■ 翻轉式層架

- 1 把層架稍微抬高就可取出。
- 2 把層架翻轉後，固定在上層或下層的位置。

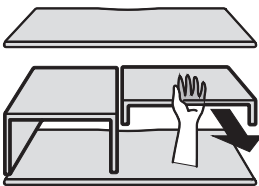

用作一般層架

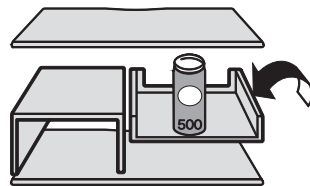

款式 1

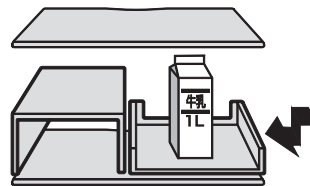

款式 2

■ 可調式置物架 (右) (左)

可以配合存放的食品做適度的調整。

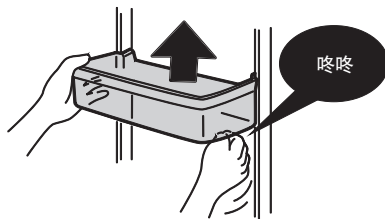

■ 軟管式容器站立架

可以直立放置如軟管式容器等的小物品。
可依照個人使用喜好，將站立架掛在棚架的邊緣。

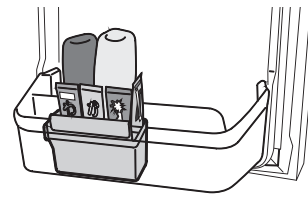
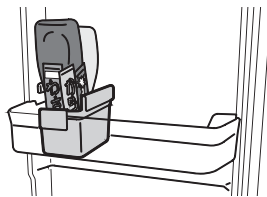

注意事項

- 請勿將站立架掛在棚架的外緣。關閉冰箱門時，有可能造成冰箱門、盒、以及食品的損壞。

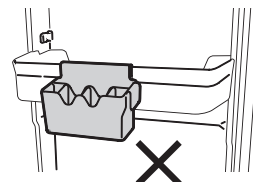

真空室

- 將真空室密閉，啟動真空幫浦，容器中的氣壓逐漸降低，可維持真空狀態（低氧狀態）。再加上維生素盒，可以抑制食品氧化。
 - 抑制氧化的功能，可以保留食品的營養成分以及原有風味，可以比以往保存更久的時間。
 - 食品用保鮮膜包覆，也不會影響真空的效果。
- 註：所謂真空是指比一大氣壓的壓力還低的空間。真空室的氣壓約為 0.8 氣壓，因為比一大氣壓還低，所以本公司將之稱為真空。

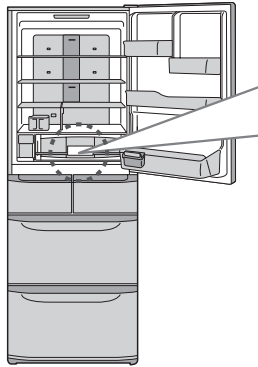

維生素盒 (附在真空室內的頂部)
低氧的狀態下自動產生維生素，可讓食品營養素長久保存。

真空容器

把手
從下面手握住把手開閉真空容器。

真空冷凍盒 (附有門)

齒輪 (位在真空冷凍盒的下方)
向上提起把手解除鎖定，藉由真空解除閥可以解除真空狀態。解除真空時會有「咻」的聲音。

真空解除閥 (藍色)

通知事項

- 為了讓真空室內成為真空狀態，啟動真空幫浦時，會產生聲音及震動，這不是異常現象。
- 真空室的門關緊，再關上冰箱門之後，即啟動真空幫浦。從啟動真空幫浦到完成真空狀態，約需要 3 分鐘的時間。在 3 分鐘以內打開箱門有可能聽不到「咻」的聲音，要確認時請等 3 分鐘之後再確認真空狀態。

注意事項

- 維生素盒不需要定期更換。請勿拆除維生素盒。

使用準備

- 冷藏室門操作面板上顯示為「真空開 +1°C」或「真空開 -1°C」便可使用。安裝時的設定是「真空開 +1°C」。
- ※ 設定為「真空開 -1°C」，亦可作為一般的冷藏室 (-1°C) [10頁](#)
- 周圍溫度為 30°C，安定狀態下的標準溫度。

真空開 +1°C

約 +1°C
(蔬菜、乳類製品、肉類、魚類等)

「真空開 +1°C」亮燈

詳細內容 [11頁](#)



真空開 -1°C

約 -1°C
(特別是保存肉類、魚類以及肉類魚類加工食品)

「真空開 -1°C」亮燈

注意事項

- 因為是用比較低的溫度來保存的，所以水分多的食品有凍結的可能。

通知事項

- 操作結束後，經過約 2 分鐘文字顯示燈則熄滅。但是急冷運轉的顯示以及 eco 運轉顯示燈則亮燈。要確認設定時請按任何一個按鍵。顯示燈則再度亮燈。
- 按真空冷凍的按鈕，可以依順序轉換成「真空開 +1°C」→「真空開 -1°C」→「真空開 -1°C」→，顯示面板以及操作聲音可以告知目前設定的狀態。 [10頁](#)

注意事項

- 有不適合存放的食品、存放時須特別注意的食品及容器。 [11頁](#)
- 週圍溫度過低時，水分過多的食品有可能結凍。

開閉真空室門

要使用真空室時，請務必將冰箱左右門打開。

開啟箱門時

用手從底部握住門的把手。



向上抬起把手，鎖被打開。



當「咻」的聲音消失時，握住把手往身前方向打開箱門。

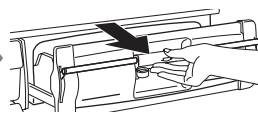

通知事項

- 當「咻」的聲音還響著時，門是不能打開的。

關閉箱門時

握住把手一直推到最裡面。

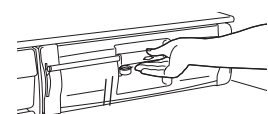
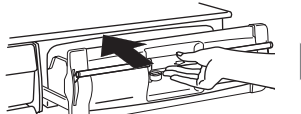

往下按把手，鎖緊箱門。



通知事項

- 如果沒有將把手壓到最底部時，則真空冷凍無法正常啟動。
- 如果把手變得比較重時，請用手掌往裡推。

注意事項

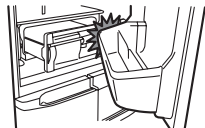

- 要關閉冰箱門時，請務必先關閉真空室門並鎖定。如果真空室門在開著的狀態下，關閉冰箱門時，則可能造成雙邊棚架、真空室、食品的破損。

- 「真空開 -1°C」、「真空開 +1°C」的顯示燈閃爍時，則表示真空機能無法正常啟動。 (☞ 27頁)



- 真空密封墊、真空解除閥 (藍色) 如果夾到食品的包裝等、有污垢、線頭、殘渣附著在上面時，則無法正常啟動真空冷凍。

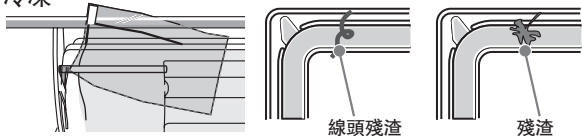

請注意避免食品包裝被夾住。

- 真空密封墊、真空解除閥 (藍色) 如果剝離或是變鬆，則無法正常啟動真空冷凍。

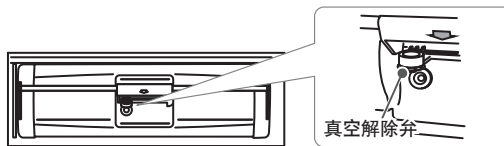

- 真空室內如果水或食品汁液溢出時，請立即擦拭。水凍結時真空冷凍盒 (附有門) 有可能無法正常啟動。



- 因為真空室是密封的狀態，如果存放水分較多的食品時，水分蒸發會在室內凝結成露水或結成霜。如果真空室內部或真空室門周邊附著了水滴或結霜，請以乾布擦拭。



- 關於真空冷凍，若遇到問題時，(☞ 27頁) 「遇到問題時」。
- 真空密封墊長期使用後，無法保持真空狀態，請更換新的密封墊。 (☞ 29頁)

日常保養清潔的方式

請取出保存在真空室內食品。

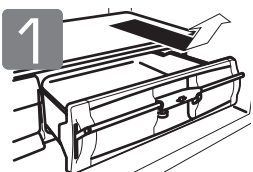

將門往身前方向拉出，將真空冷凍盒 (附有門) 輕輕地抬起抽出。



用柔軟的布沾溫水擦拭真空密封墊以及內側的密封墊承托部。

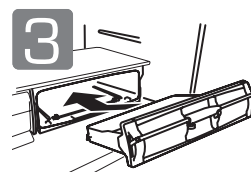
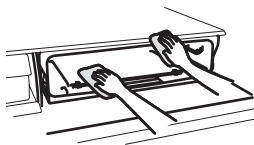

讓真空冷凍盒 (附有門) 在真空容器中滑動推入。最後再將把手鎖住。

取下真空密封墊，保養清潔時

取出真空冷凍盒 (附有門) 之後，請依照下列順序清潔真空室門以及真空密封墊。除了真空室門及真空密封墊之外，請勿拆卸其他零件。

■ 拆除真空室門的方法

1

要拆除真空室門時，在冷凍盒下方墊著保鮮膜的盒子，讓冷凍室門呈懸空的狀態，如此的方式比較好拆卸。

2



扣鉤
拆除冷凍盒前面的扣鉤。

3



將真空冷凍門往下押，使軸脫離。

4

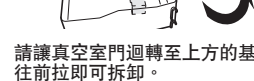

迴轉基準
請讓真空室門迴轉至上方的基準點。往前拉即可拆卸。

■ 真空密封墊的保養清潔

1



突起

以手握住右上方的真空密封墊的突起，小心地拆下密封墊。

2

用海綿等柔軟的材料用水清洗污垢，然後用乾布擦乾淨，讓其自然乾燥。擦拭冷凍室門的真空密封墊凹槽內的污垢。※ 請勿使用洗潔劑。

3

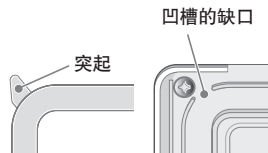

凹槽的缺口

突起

將真空密封墊的突起對準凹槽上的缺口，牢牢地固定。

■ 真空室門的安裝方式

1



真空室門的軸

軸承

真空室門的軸對準冷凍盒內的軸承。

2



請讓真空室門迴轉至上方的基準點。

3



押著冷凍盒的底面，將真空室門往上拉。再確認突起是否有在定位。

注意事項

- 真空室門請勿用水清洗。
- 真空密封墊如果使用溫水以外的洗潔劑，則有可能破損、變形、變色，無法保持真空狀態。
- 如果真空密封墊鬆了或是接觸不良，則有無法維持真空狀態。

冷凍室

上層冷凍室

- 急速地冰凍將鮮味密封的急速冷凍機能。  17頁
- 請使用於急速冷凍肉類或魚類時。

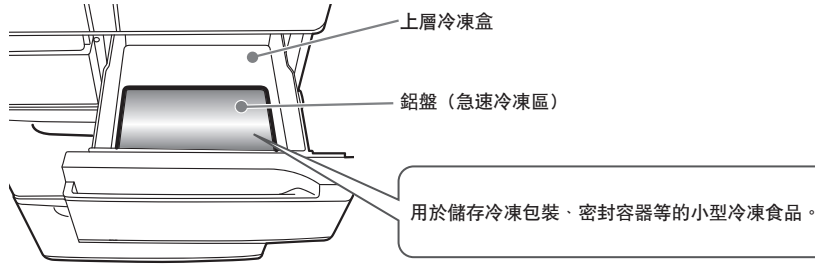

下層冷凍室

- 內配 3 層冷凍盒，能夠充分地存放，整潔地收拾。
- 適於存放需長期保存的東西，容易融化的冰淇淋等。

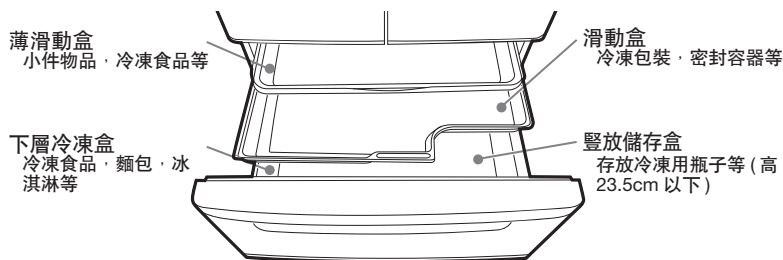

- 將上層冷凍室的鋁盤往薄滑動盒左側移動，便可作為急冷凍盒使用。

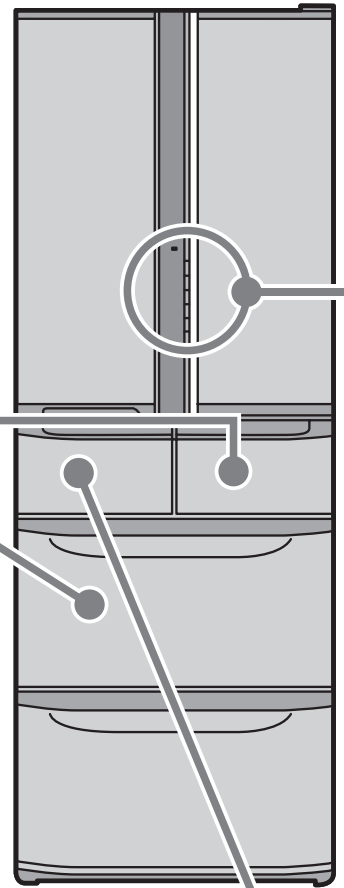

製冰室 (自動製冰機)
的使用方法

 18頁

可容納食品的高度

- 請遵守每個盒子所能容納的食品高度。
- 箱門無法緊閉、冰箱冷卻效果變低。還有可能會造成食品、各盒子的損壞。
- 請勿讓薄型盒或是小件物品盒的底部接觸到其他食物。

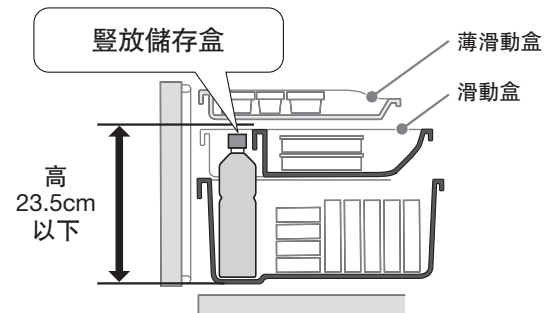
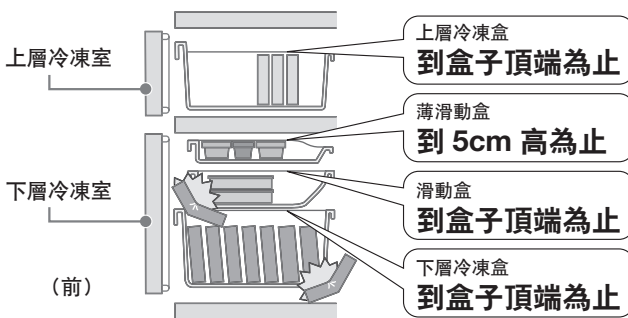

- 薄滑動盒裡請勿存放 500mL 的塑膠飲料瓶。塑膠飲料瓶凍結後會膨脹，導致滑動盒拉不出來。
- 請勿將薄滑動盒以及滑動盒拆去使用。
- 食品會堵塞或掉落到冷凍盒的後面，導致關不上門。
- 在豎放儲存盒裏儲放高的食物時，請注意不要碰到薄滑動盒及滑動盒。
- 請只使用於存放冷凍專用塑膠瓶類及能夠冷凍的食品。

調節冷凍室的溫度

冷凍室門操作面板

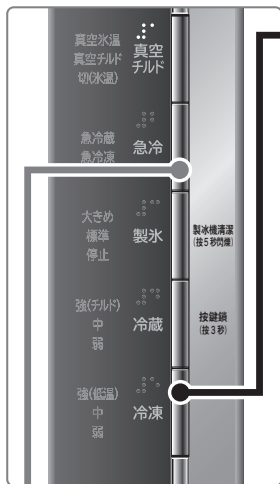

冷凍室溫度的調節

按冷凍室按鍵調節。

是在環境溫度 30°C、不放食物、關著門、安定時的標準值。

強 (低溫)	約 -23 ~ -20°C (低溫冷凍)
中	約 -20 ~ -18°C
弱	約 -18 ~ -15°C

- 通常請使用“中”的位置。溫度因使用條件而有所變動。
- 急速冷凍運轉時，溫度比左記的溫度更加低。
- 在“強 (低溫)”長時間使用時，冰淇淋類會變硬、儲存的食品的解凍時間會較長。

通知事項

- 操作結束後，經過約 2 分鐘文字顯示燈則熄滅。但是急冷運轉的顯示以及 eco 運轉顯示燈則亮燈。 (P.10 頁)
- 操作部分的詳細使用方式 (P.10 頁)
- 調節更細微的溫度時 (P.29 頁)

急速冷凍

1 上層冷凍室的鋁盤上放用保鮮膜包好的食品

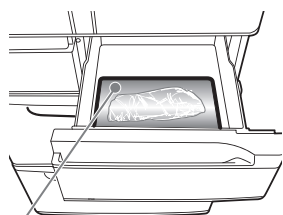

急速冷凍盒

2 按急冷鍵使「急冷凍」的顯示亮燈※

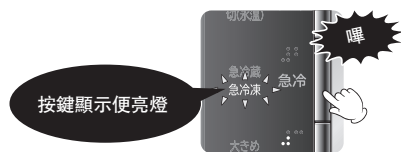

※ 設定為「急冷凍」之後，「急冷凍」以外的顯示燈經過約 2 分鐘即熄滅。

3 約 90 分鐘「急冷凍運轉」自動終了，「急冷凍」顯示自動熄滅

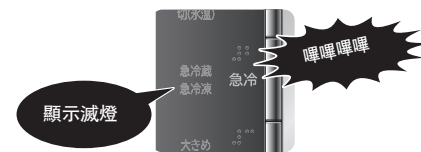

中途停止時在其他顯示再次亮燈後按急冷鍵使顯示滅燈

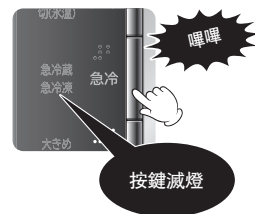

- 「急速冷凍」中，為了優先冷卻冷凍室，特別是冷藏室的門開關頻繁的時候，冷藏室的溫度容易升高。
- 可以直接冷凍熱的飯等。放入熱的食品時，會有燙傷的危險，請注意！建議冷卻到 50 ~ 60°C 之後再放。
- 「急速冷凍 (急速製冰)」結束後的 60 分鐘以內，再次按急冷鍵時，顯示雖然燈亮，但不運轉。60 分鐘過後才開始運轉。
- 為了防止食品粘在鋁盤上，請務必包上保鮮膜。
- 將食品分開小塊、薄片，不但能快速冷卻到中心部，而且方便取出。

遇到問題時

這種情況下

請檢查一下。是這原因嗎？

不夠冷
結霜、結露
冰淇淋太軟

- 頻繁地開箱門嗎？
→ 建議您在開著箱門時動作迅速一點，盡量少開。
- 食品或袋子是否被夾著，門關緊了嗎？
→ 請在關著門的狀態檢查一下密封墊處有無縫隙。
- 是否過分塞堵食品，是否一次存放入了大量的食物呢？
→ 請遵守可容納食品的高度，儲放量注意不要影響門的開閉。
→ 食品之間請空開間隙存放。
- 上層冷凍盒、薄滑動盒正確安裝好了嗎？
→ 請正確安裝好。 (P.22 頁)

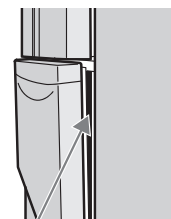

密封墊之間有間隙的狀態

注意事項 ● 頻繁地開閉箱門會使食品的温度上升，冰淇淋等會變軟。

製冰室（自動製冰機）

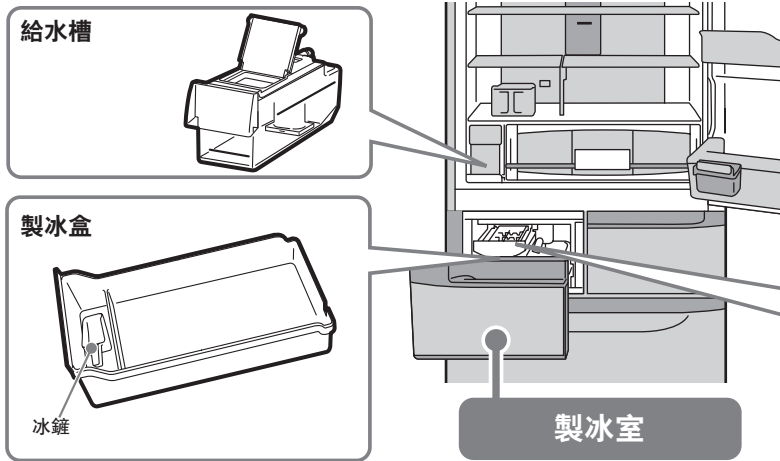

冷藏室門操作面板

冰的大小 / 停止製冰的開關

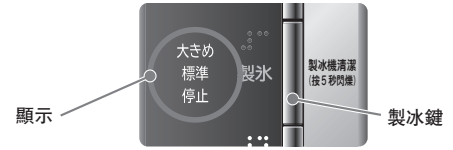

自動製冰機

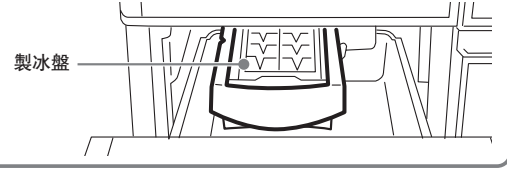

製冰方法

1 自動製冰機的設定

請按製冰鍵選擇冰的大小。

19頁

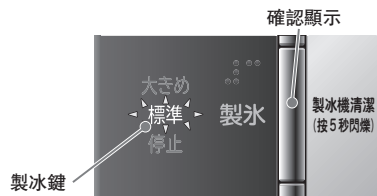

2 取出給水槽。

如果水減少到「給水線」，請加水。

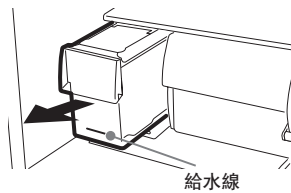

3 打開蓋加水。

加到滿水線。



4 再裝回給水槽。

推入到超過「水槽安裝位置」的線位。
※ 給水槽傾斜會將水灑出。
水灑出請立即擦乾。

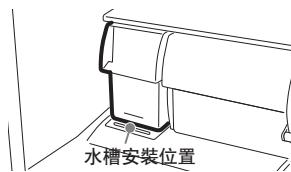

初次製冰時、或是一星期以上沒有製冰時，請操作「製冰機清潔」。

23頁

5 自動開始製冰運轉，在製冰盒裏儲冰。

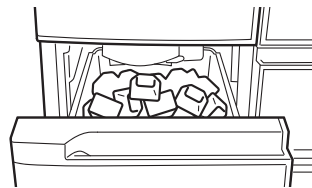

通知事項

初次使用時，最初的製冰可能需要 24 小時以上。
通常 2 ~ 3 小時可以製 8 顆冰。

注意事項

- 建議使用「可搬運的自來水」*
* 請向當地相關機關確認。
- 因衛生上的理由，請至少每週更換一次水，並清洗容器。
- 使用含豐富礦物質的礦泉水製作冰塊時，會產生白色的粉末，這是礦物質成分，在衛生上無害。

- 如下列所示，因為容易受到細菌污染，平常請三天清洗容器一次。



- 由於會導致故障，或是會造出畸形・連體的冰等，請不要使用這些（液體）。



警告

- 請勿觸摸自動製冰機的機械部位。
- 當製冰盤旋轉時，會有受傷的危險。

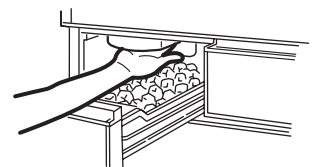

切換自動製冰機的設定內容

用自動製冰機製冰時

標準製冰
按製冰按鈕使「標準」燈亮

製大顆的冰
按製冰鍵使「大顆」燈亮

停止製冰

按製冰鍵使「停止」燈亮後自動製冰停止、不製冰。

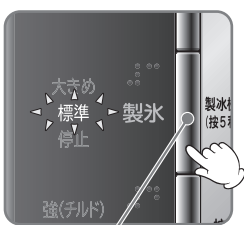

製冰鍵

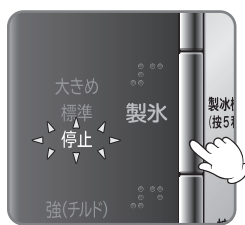

用於急需製冰時 （急速製冰）

按急冷鍵、「急冷凍」的顯示亮燈，轉為急速製冰運轉，製冰時間縮短。

17頁

※ 約 90 分鐘後回復通常運轉。

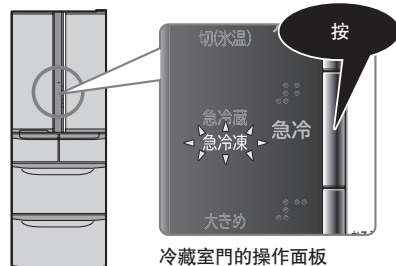

冷藏室門的操作面板

通知事項

- 操作結束後，經過約 2 分鐘文字顯示燈則熄滅。但是急冷運轉的顯示以及 eco 運轉顯示燈則亮燈。
- 每按製冰鍵一下，設定按照「標準」→「大顆」→「停止」→…的順序切換，以顯示與操作音告知設定狀態。
- 在切換製冰停止時，「停止」顯示會閃爍，約 20 秒後自動滅燈。
(不是故障)
- 用完製冰「停止」以後，請將給水槽洗乾淨、弄乾並放回所定的位置。
特別是淨水濾片，請徹底弄乾。(清掃方法 23頁)
- 用製冰「停止」的話，可停止自動製冰時的運轉音(離冰·給水等)。

製冰時間與製冰能力

一次的製冰時間（1 回 8 個）

冰塊大小	標準	大顆
正常運轉	約 110 分 ~ 140 分	約 150 分 ~ 170 分
急速製冰	約 70 分 ~ 90 分	約 90 分 ~ 110 分

製冰盒的收納量

冰塊大小	標準	大顆
正常運轉	約 90 個	約 60 個
把冰塊向前移的狀態	約 150 個	約 120 個

● 以下的情況會造成製冰時間更長。

- 首次使用時(可能需超過 24 小時)
- 箱門常被開啟 / 關閉
- 清洗冰盤過後
- 當冰箱內在同一時間儲存大量的食品時
- 當停電時
- 當冬天四周的氣溫低，等等

通知事項

- 自動製冰機上的儲冰量測知桿(通常看不見)自動檢測儲存冰塊的數量。如果儲存的冰塊達到一定數量會自動停止製冰，當冰塊數量減少時會恢復製冰。
- 最大儲冰位置標準線表示的是冰塊平放在冰盒中時的最大容量。
如果冰盒內只有一部分冰塊而還沒有滿，但是冰塊碰到了最大儲冰位置標準線，即使冰塊數量很少，製冰機也會停止製冰。

注意事項

- 自動製冰設定時，製冰盒中請勿放冰以外的冷凍食品等。
(會造成不能製冰、食品碰到製冰機的部件、門打不開、損壞部件。)

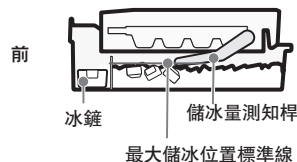

冰鏟

儲冰量測知桿

最大儲冰位置標準線

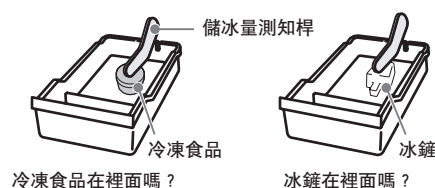

冷凍食品在裡面嗎？

冰鏟在裡面嗎？

蔬果保鮮室

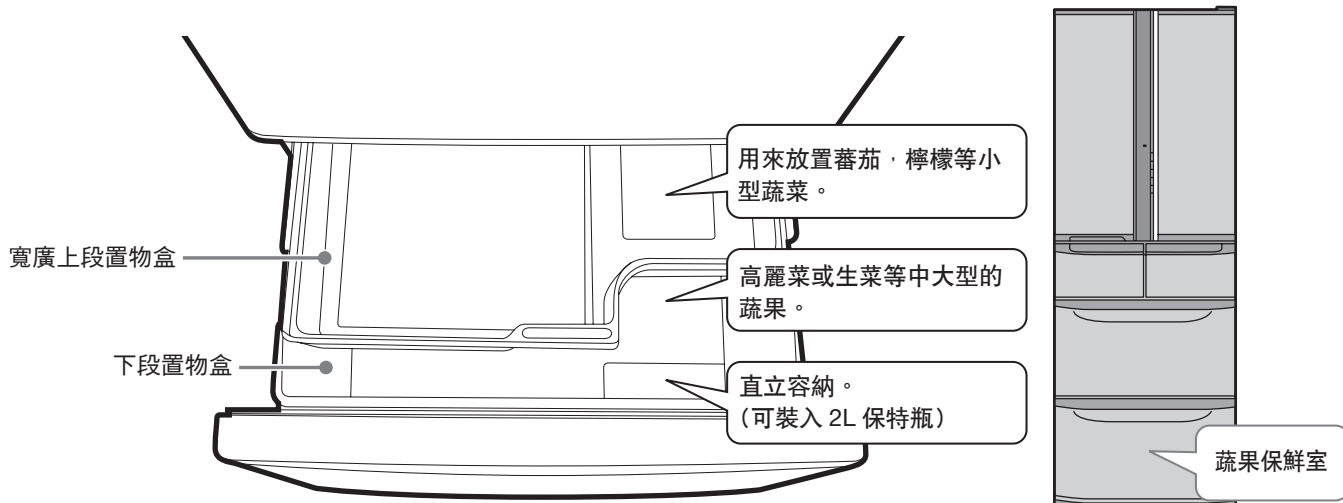

下段置物盒 · 寬廣上段置物盒

冷氣不會直接吹著蔬果，溫和而確實地冷卻。不用保鮮膜也能夠使蔬果的水分保持新鮮。

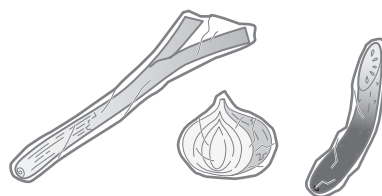
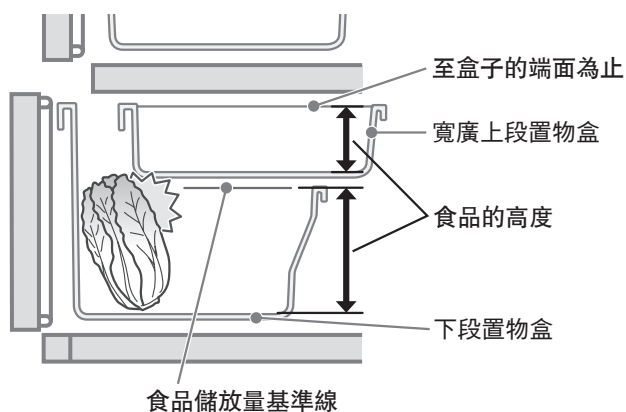

- 這個時候要用保鮮膜包住蔬菜
- 擔心大蔥·韭菜·蔥蒜等的氣味傳到別的食品上時
- 儲存用剩了的蔬菜或水果時
- 蔬果儲量少的时候，或是已包裝的蔬菜多的時候
- 介意蔬果保鮮室內的結霜時

注意事項

- 請勿將食品塞入滑動式瑣碎食品整理盒下方。
 - 如果冰箱門沒有關緊，冷凍狀況會不好。
 - 食品，各種抽屜會破損。
- 根據塑膠瓶的種類，有些是不能儲放的。
 - 另外，塑膠瓶的蓋子沒關緊也不能存放。
- 外氣溫度低的時候，溫度會有降低的可能。
- 因蔬果保鮮室的濕度較高，可能因存放的蔬果量或種類不同，可能在上段置物盒或蔬果保鮮室的頂部凝結露水。當水積多時可能對食品造成損傷，請以乾布擦拭。

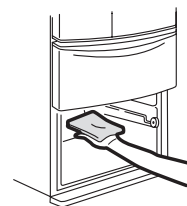

通知事項

- 蔬果保鮮室的門要慢慢的開閉。如開閉力量太強，直立存放的食品（瓶裝飲料等）會翻倒。

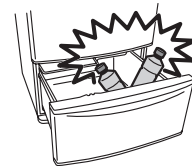

保養方法 / 冰箱內 · 冰箱外的保養

發現髒時

- 立即擦乾淨。
看不到的部分也請一年清掃一次。
 - 用柔軟的布濕潤溫水擦。
污垢難以擦掉的時候，可將廚房用的中性洗潔劑稀釋使用，用溫水濕布擦乾淨。
因為有些洗劑是不可使用的，請參考本頁的**注意事項**。
 - 卸除部件時，請先將食品取出來。
- 注意事項**
- 因為置物箱以及抽屜式軌道的接觸面上都塗有潤滑劑，請勿擦拭此部分。(潤滑劑是符合食品衛生法的標準。)

電源插頭

- 附著在電源插頭上的灰塵擱置而不清掃的話，會導致火災。請每年清掃一次。
- 1 將電源插頭從插座拔掉。
 - 2 檢查
 - 電線有損壞嗎？
 - 電源插頭髮熱嗎？
 - 3 用乾布擦去灰塵等。
 - 4 將電源插頭確實插入插座上。

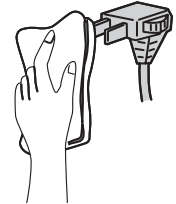

冰箱內 · 冰箱外的清掃



警告

清掃時，請一定要把電源插頭從插座拔掉。

冷藏室門的操作面板

- 冷藏室門的操作面板請用柔軟的布乾擦。
- 請勿淋水。
否則會導致故障。



箱門表面

- 箱門表面請用柔軟的布濕潤溫水擦。
- 有關不鏽鋼顏色的門，請順著表面的細線條的方向擦拭。

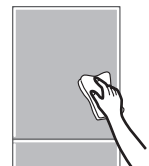

箱門密封墊

- 由於此部分容易髒，請擦乾淨。

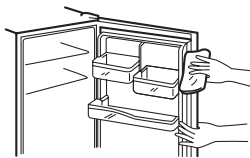

汁液承接處

- 積著汁液時，請擦乾淨。

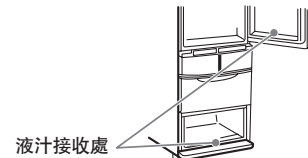

冰箱背面 · 地板

- 1 將腳座護蓋往身前拉出卸下。
安裝時，從正面插入

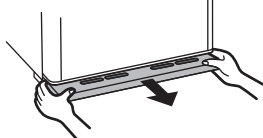

- 2 使調整腳浮起離開地面，將冰箱往身前筆直地拖出。
若是容易刮壞的地板，則鋪上保護用的板等

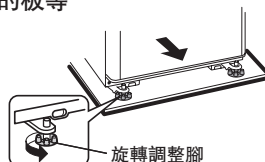

- 3 擦乾淨背面 · 牆壁 · 地板上的污垢
背面由於空氣對流的關係，容易堆積灰塵而弄髒。

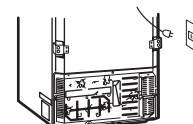

注意事項 箱門 · 塗裝面 · 塑膠會有受損 · 變色的可能。

- 請勿使用以下的東西。
 - 鹼性和弱鹼性的廚房用洗潔劑 · 去污粉 · 肥皂粉 · 石油 · 熱開水 · 刷子 · 酸 · 揮發油 · 稀釋劑 · 酒精 · 漂白劑等等 (請確認洗潔劑的「根據家庭用品品質表示法表示」的「液性」欄)
- 沾了食用油 · 柑橘類的果汁 · 食品汁液的時候，請務必擦乾淨。
- 若使用化學抹布時，請遵守其使用上的注意事項。

卸除組件的方法

附有門的冷凍盒

- 將門往身前拉，附有門的冷凍盒輕輕地拿起將之抽出來。詳細請參閱

14, 15頁

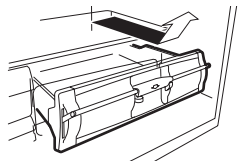

箱門置物架

- 一邊輕敲底部左右一邊提高便可卸取。
安裝時，請完全裝入到最底。

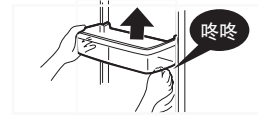

固定層架

- 往身前拉出來、將右下2處的扣鉤拆開取下。

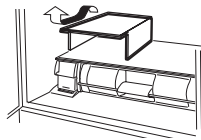

翻轉式層架

- 稍微向上拉出。

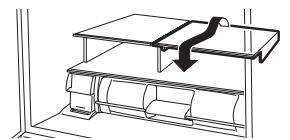

可調式層架·低層架

- 1 稍微提高層架的裏頭，往身前拉出

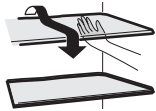

- 2 如圖，將層架豎起後翻轉、卸除。

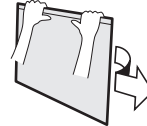
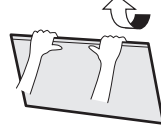

安裝時，把層架插放到最裏面之後，稍微提一下層架的裏頭推進去。
(將層架的鈎扣掛在最裏面的配件上)

注意事項 直接把層架拉出會有可能損傷箱門。

製冰室·上層冷凍室

- 打開門，向前方取出。
安裝時要將箱底面裝載在框子上。

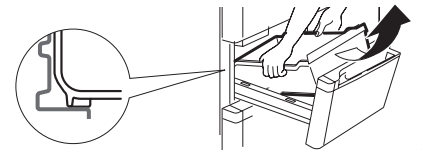

下層冷凍室

- 1 打開門後，拉出薄滑動盒及滑動盒。

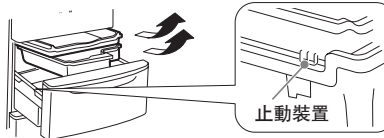

安裝冷凍盒時，請將盒子左右突出的部分向門框兩旁的洞角插入固定。
請將滑動盒兩旁的止動裝置插入下層冷凍盒的外側。

- 2 向上取出下層冷凍盒。



蔬果保鮮室

- 1 將箱門向面前側完全打開。如圖將瑣碎食品整理滑動盒向上推後拆下。

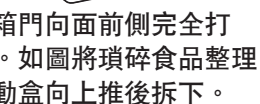

- 2 將箱門稍微往上扳後，再慢慢向外拉開，讓箱門傾斜。

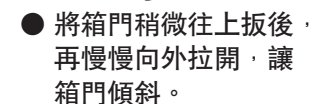

- 3 將蔬果箱斜的方向向上抬起。

- 安裝時，請將下段箱子左右內側突出部分插入框的四方孔內架，將下段箱子的邊緣置在框架上固定。

抽屜式箱門的安裝方法

製冰室·上層冷凍室

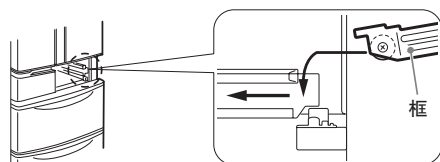

蔬果保鮮室·下層冷凍室

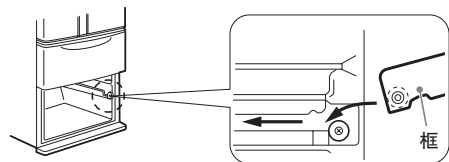

自動製冰機的保養

製冰機清潔

- 初次使用時
- 一週以上沒有使用時

可自動清洗製冰盤與給水路。

操作前請確認以下事項。

● 給水槽

- 是否有裝水
- 是否裝設在正確位置

● 製冰盒

- 有殘留冰塊時請清除

都確認完了之後再操作下一個步驟。

1 請在所有的門都關閉之後，使顯示燈亮，持續按住製冰按鈕 5 秒以上。

「大顆」「標準」「停止」顯示閃爍，請在蜂鳴聲響之後放開手指，「製冰機清潔」便開始。

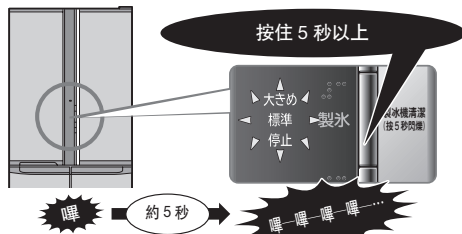

- 大約 3 分鐘之間，顯示亮燈、蜂鳴聲會一直響。
- 操作「製冰機清潔」功能時在途中無法停止。
- 操作「製冰機清潔」功能當中，如果打開冰箱的任何一個門時，則有可能無法正常運作。請在製冰機清潔運作結束之前不要開啟冰箱門。
- 冰箱門警報音設定在停止的狀態下警報音也會發出聲響。

2 約 3 分鐘過後，蜂鳴聲停止，顯示滅燈以後，除去製冰盒內的冰及水，擦乾淨。

卸取盒子時，請注意不要把水倒灑。

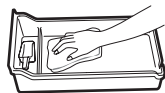

將臨時移放在別的冷凍室內的冰塊放回製冰盒裡。給水槽裡剩下的水，可以繼續直接使用。

給水槽

● 清掃的標準次數

自來水	1 週以內 1 次
礦泉水・井水・淨水器的水・涼開水等 (不含氯素的水)	3 天 1 次

不含氯素的水與自來水比較，容易產生水垢・發黏，因此為了防止細菌繁殖請定期清洗水槽。

● 請將密封墊圈從水槽蓋取下，用柔軟的海綿等清洗乾淨。

● 開蓋方法

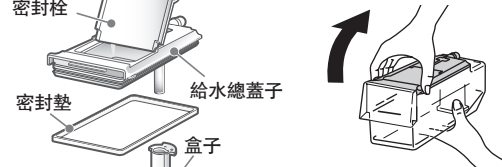

● 關蓋方法

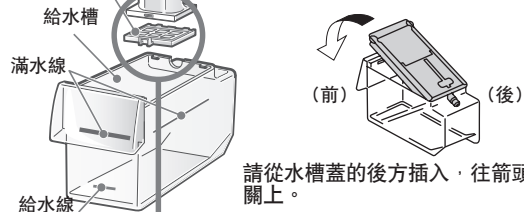

淨水濾片

(約 3 ~ 4 年為更換的基準) 29 頁

1 旋轉盒子從水槽蓋上卸取下來。



2 用手指扳著扣鈕將淨水濾片從盒子裡取下來。

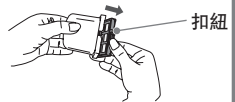

3 使用柔軟的海綿等用水洗乾淨。

請不要使用洗潔劑等。

通知事項 ● 設定在製冰停止而長期不用自動製冰機時，請將給水槽洗乾淨弄乾後放回所定的位置。

● 特別是淨水濾片，請徹底弄乾。

製冰盤 ● 每年清掃 1 次

1 為了停止往製冰盤給水，請按製冰選擇鍵讓其示為「停止」。(停止製冰)

※ 若顯示燈閃爍時，請約等 20 秒，顯示燈滅後再進行以下操作。



2 打開製冰室的門。

- ① 扳下扳手
- ② 拉出框子。
- ③ 護蓋 (▲部) 往身前方揭起
- ④ 從框子裡取出製冰盤。

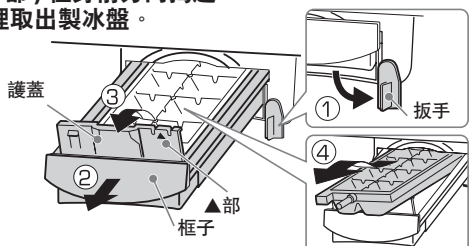

通知事項

● 製冰盤的「框子推不到底」時，驅動製冰盤的馬達有可能已啟動。一旦卸除製冰盤，推入框子關上製冰室的門後，請約等 1 分鐘。製冰盤的驅動馬達的準備完成後便可安裝。

3 騰空製冰盤，用流水簡單沖洗。



請勿使用刷子去污粉等容易刮傷的東西。

4 ① 安裝製冰盤 ② 關上護蓋。 ③ 將框子水平地插入到最裏面 ④ 扳上扳手。

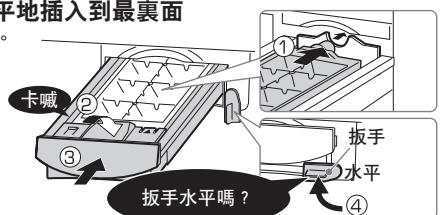

5 請按製冰鍵，使「大顆」或「標準」的顯示亮燈。(開始自動製冰)



遇到問題時

在委託修理之前，請再次檢查以下幾點。狀況仍然不好的時候，請聯絡所購買的經銷店或敝公司客戶服務部。

購買後，初次使用時常有的疑問

初次使用時
不夠冷。
不能製冰

- 夏季或食品多的時候，需要時間冷卻。
→ 剛安裝後，可能需要約 4 ~ 24 小時以上。
- 初次使用時，冰箱內冷卻以後才開始製冰運作，所以較費時。
根據食品的量及存放方法，最初的製冰可能需要 24 小時以上。
→ 請迅速地開閉門或盡量少開。
→ 食品之間請空開間隙存放。

這種情況下

請檢查一下。是這原因嗎？

操作面板沒有反應

操作面板沒有反應

- 操作部鎖定功能，是否選擇了「設定」呢？ [☞ 30頁](#)
- 冷藏室門有沒有打開呢？請關上之後，再進行操作。

自動製冰不正常

完全不能製冰

- 冷藏室內的操作面板的「製冰選擇」顯示燈滅了嗎？ [☞ 19頁](#)
- 給水槽推入到超過「水槽裝置位」的裏面了嗎？ [☞ 18頁](#)
- 製冰盒的裡面存放了冰塊以外的東西嗎？ [☞ 19頁](#)

很難結冰
製冰盤裡不給水

- 是否頻繁地敞開門，是否一次存放了大量的食物呢？
冰箱內恐怕是沒有充分冷卻。
→ 請試試在冰箱內冷卻前，盡量減少開閉門。
→ 請試試盡量空開儲存食品之間間隙。
- 冬季每結一次冰可能需要 4 小時以上。
- 從「停止」顯示亮燈狀態，到讓「冰塊大小 (大顆粒，標準)」顯示亮燈之後，結冰的時間會比平常需要更長的時間。
- 食品或袋子是否被夾著，門關緊了嗎？
→ 請在關著門的狀態檢查一下密封襯條處有無縫隙。

冰塊有凸起

- 是製冰盤的溝上積水凍結了。不是異常。

所儲存的冰塊變圓
冰塊之間粘在一起

- 長時間積儲著沒使用的舊冰塊，會自然變小，粘在一起。
- 是否頻繁地敞開門，是否一次存放了大量的食物呢？冰箱內的溫度上升，積儲的冰塊，會變小並粘在一起。
- 有可能是箱門或抽屜一時沒關緊。

結的冰塊很小

- 給水槽的水剩的很少時，會結小的冰塊。
→ 請試試加水加到給水槽的滿水線。 [☞ 18頁](#)

結成的冰塊一開始
就粘在一起

- 製冰盤裡的給水量不均勻時，會結成粘在一起的冰塊。
→ 請試試加水加到給水槽的滿水線。 [☞ 18頁](#)
- 若製冰盤裡有損傷，冰塊結成時，難以從製冰盤上取下來，會粘在一起。
多次發生同樣情況時，請與經銷店洽商，嘗試更換製冰盤。

冰塊裡有白色混濁

- 是因為混在水中的氣泡被封在冰塊裡面了。
→ 不是異常。
- 用礦泉水製冰了嗎？
→ 水中含有的礦泉物凍結會變白而混濁。
在水裡融化了也會有白色混濁，不過無害。

製冰盤的框子拉不出來

- 製冰功能的「大顆粒」「標準」的顯示燈亮著嗎？
→ 自動製冰機正在製冰時拉不出來。請熄滅「製冰選擇」的顯示燈。
顯示燈不滅而開始閃爍時，請約等 20 秒，顯示燈滅後再拉出。 [☞ 23頁](#)

這種情況下

請檢查一下。是這原因嗎？

不冷

不冷
結霜・結露
冰淇淋太軟

確認食物的存放狀況

- 食品或袋子是否被夾著，門關緊了嗎？
→ 請在關著門的狀態檢查一下密封墊處有無縫隙。
- 是否過分塞堵食品，是否一次放入了大量的食物呢？
→ 請遵守可容納食品的高度，儲放量不要影響門的開閉。
- 食品之間請離開間隙存放。
- 上層冷凍盒・薄滑動盒安裝好了嗎？
→ 請正確安裝好。 (P. 22頁)

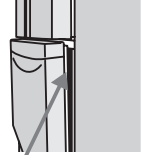

密封襯條處發生有縫隙的狀態

確認安裝

- 根據電冰箱的設置場所及空隙・環境狀況等，會有難以冷卻的可能。
請確認是否正確安裝了。 (P. 8頁)

確認設定溫度

- 溫度設定為「弱」時會是冷卻不足。 (P. 12, 17頁)
→ 冷卻不足的室內溫度設定請切換為「中」或「強」。
- 在夏季等，電冰箱的環境溫度高嗎？
→ 冷卻不足的室內溫度設定請切換為「強」。

確認冰箱的使用方法

- 冰箱門敞開著時，庫內的溫度會逐漸上升。頻繁地開閉或是長時間敞開著門的話，庫內的溫度會難以下降。
→ 嘗試減少開閉次數，迅速地開閉等。

結霜・結露

冰箱內及門・抽屜
框上結霜・結露

- 有可能是門或抽屜有時沒關緊。
→ 關閉抽屜及門的時候確認是否關緊了。
- 有可能是開關次數多、長時間連續打開了。
→ 試試減少開關次數，迅速地開關等。
- 防止結露用的發熱器減弱時、濕度高時，旋轉隔層部會附著露水。 (P. 29頁)

冰箱的外側結露
(外裝、門的密封
墊、門、抽屜等)

- 下雨天等室內濕度高的時候會結露。
- 冰箱內及門框接觸到外面的暖空氣時，有可能結霜、結露。
→ 請用乾布擦乾淨。

冰箱中凝結露水

- 冰箱門開閉次數過於頻繁、及冰箱周圍濕度過高時，壁上會有起霧現象，鋁板的冷氣出風口附近可能凝結成露水。
→ 請用乾布擦拭。

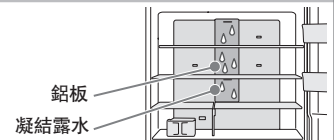

蔬果保鮮室中凝結
露水

- 蔬果保鮮室比其他的儲存室的濕度高 (是為了不讓蔬果乾燥，可以長久保存所設計的)
→ 如果在意蔬果保鮮室的高濕度，請將食物以保鮮膜包覆之後在放入蔬果保鮮室內。
- 凝結露水過多時，水可能積在蔬果保鮮室。
→ 請用乾布擦拭。

太冷

太冷
凍結了

- 溫度調節為「強」了嗎？→ 請設定為「中」。 (P. 12, 17頁)
- 環境溫度是否 5°C 以下呢？→ 請將溫度調節為「弱」。 (P. 12, 17頁)
- 請不要放在冷氣吹出口的前面。

遇到問題時

遇到問題時



這種情況下

請檢查一下。是這原因嗎？

聲音不對

冰箱發出的聲音嘈

- 有可能是沒有正確安裝好

原因	處置
地板彎曲	鋪上堅固的板以後，在板上安置。  8頁
冰箱靠著牆或家具等	電冰箱的周圍空開間隙安置。
腳座護蓋脫落了	請正確安裝好腳座護蓋。  8頁

- 購買後，剛開始使用等冰箱還未冷卻時，箱門開閉頻繁時，周圍的溫度高的時候，由於壓縮機高速運作，可能會感覺到聲音大。
→ 充分冷卻後，聲音會變小。

運作音長

- 是為了讓壓縮機慢慢地運轉，是在省電運作。

時常聲音變大

- 是因為運轉力隨著庫內的溫度變化在變更。

其他 例如聽到這樣的聲音時

- 如下的聲音是正常運作時發出的，並不是異常。

聲音的種類	聲音的發生源
<ul style="list-style-type: none"> · 像流水的聲音（滴哩滴哩） · 像趾撞的聲音（嘖嘖・嘖嘖） · 像沸騰的聲音（噼噼噼） · 像燒肉的聲音（唧～） 	是為了冷卻電冰箱的冷媒流動聲・融霜時的水流聲・蒸發聲。
<ul style="list-style-type: none"> · 像摩擦的聲音（啾啾） 	是冷藏庫的溫度變化時，部件的摩擦聲。
<ul style="list-style-type: none"> · 像什麼被卡著的聲音（嗒嗒嗒嗒） · 像呻吟的聲音（嘍～） · 像剛關門時的聲音（呸～） 	是控制庫內溫度的電氣部件的運作聲。
<ul style="list-style-type: none"> · 自動製冰機的聲音（啾～） （嘎啞嘎啞） （咯啞咯啞） 	是冰塊從自動製冰機的製冰盤離落時，以及製冰盤裡給水時的聲音。給水槽空的時候每兩小時也會發出聲音。 「製冰選擇」的顯示滅燈時便是製冰停止，就不會發出聲音。  19頁
<ul style="list-style-type: none"> · 時常有的聲音（卡嗒卡嗒） 	為了冷卻冰箱內開始運作時的聲音。

冰箱發熱

電冰箱的側面發熱 箱腳底下吹出暖風

- 為了讓冷卻裝置運作時所發出的熱氣向外排而會發熱。
→ 剛剛安置後或是夏季，可能會有 50 ~ 60℃，不過安全上以及性能上沒有問題。

這種情況下

請檢查一下。是這原因嗎？

真空冷凍上的問題

「真空開 +1°C」
或「真空開 -1°C」
的顯示



真空機能無法正常啟動，請確認以下各項。

- 把手是否有推到最終的位置，牢牢地鎖住？
→ 如果沒有鎖住，則無法啟動真空機能。
- 真空密封墊與承托部之間是否夾著食品的包裝袋、頭髮等？
→ 只要有些微的碎屑被夾在其中，則無法維持真空。請將碎屑清除。
- 真空密封墊、真空密封墊承托部是否髒了？
→ 髒了請以布擦拭乾淨。(☞ 14, 15頁)
- 真空解除閥(藍色)是否脫落了，鬆了？
→ 請牢固地裝設在把手的洞。

打開時，
不發出「咻」的聲音



- 真空墊部分是否夾著食品的包裝等，有無附著污垢、線頭及垃圾呢？(☞ 14, 15頁)
→ 食品的包裝被夾著時，請取除。
→ 請清掃髒了的真空墊。
- 真空墊及在把手下部的真空解除閥(藍色)是否脫落了，鬆了呢？
- 「真空開 -1°C」、「真空開 +1°C」鍵的顯示亮著燈嗎？
- 把手往上翹著嗎？
- 真空室剛關閉後時，由於真空泵是在開始運作的準備狀態下，可能不發出「咻」的聲音，並不是故障。

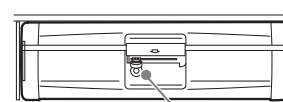
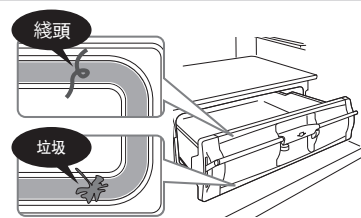

真空解除閥

不知道是否在真空

- 打開時如有「咻」的聲音，便是正常。

把手不能上鎖

- 真空墊部分及真空冷凍盒的裏面是否有食品等被夾著呢？(☞ 14, 15頁)
- 真空冷凍盒前面和門的軸是否脫落了？(☞ 14, 15頁)

真空室的周圍發出
「呸～」的聲音和振動

- 是真空泵的運作聲音。不是異常。
- 如夜間等介意有聲音的時候，可以停止真空泵的運作。
- 頻繁地有聲音及振動時，有可能是門上夾著東西或是真空墊髒了。(☞ 14, 15頁)

真空室內部
有水滴或結霜

- 因為真空室是密封的狀態，如果存放水分較多的食品時，水分蒸發會在室內凝結成露水或結成霜。
→ 水分較多的食品建議以保鮮膜包覆
→ 如果附著了水滴或結霜，請以乾布擦拭。

真空室的食品凍結

- 是否存放了茄子、黃瓜等不耐低溫的蔬果呢？(☞ 11頁)
- 設定是在「真空開 -1°C」、「真空開 -1°C」嗎？(☞ 14頁)

遇到問題時

遇到問題時

這種情況下

請檢查一下。是這原因嗎？

有異味

<p>冰塊有異味</p>	<ul style="list-style-type: none"> ● 給水槽・淨水濾片髒嗎？冰塊舊嗎？ → 為了防止「發黏」「水垢」，請定期清洗。 (P. 23頁) ● 由於自來水中的氯元素凝縮，氯的氣味會重。
<p>冰箱內有異味</p>	<ul style="list-style-type: none"> ● 是否直接地儲放了氣味重的食品呢？ → 脫臭機能是不能完全去除所有的氣味。 請用保鮮膜等密封後儲放。
<p>有塑膠味</p>	<ul style="list-style-type: none"> ● 是因為在庫內使用了多數的塑料部件，不過，充分冷卻後自然就會慢慢減輕。

箱門高低不平衡以及歪斜

<p>左右箱門高低不平衡箱門歪斜</p>	<ul style="list-style-type: none"> ● 有可能是設置地方沒有水平。 由於地板太軟加上儲放物的重量使箱腳下沉等的原因，箱門會有錯位。 → 性能上沒有問題，可以照舊使用，不過介意的話，試試調整左右的調整腳。 (P. 8頁) → 冰箱本體傾斜的時候，請鋪上 1cm 以上厚的堅固的板。
<p>關上門之後再立刻打開時感到吃力</p>	<ul style="list-style-type: none"> ● 是因為進入了冰箱內的空氣忽然受到冷卻，氣壓一時變低。
<p>關門時其他的門會開</p>	<ul style="list-style-type: none"> ● 因為各室的冷氣通路是相通的，關門時由於風壓使其他門會一瞬間打開。

其他

<p>觸碰到機體會感覺到微量的電流</p>	<ul style="list-style-type: none"> ● 電冰箱會帶有靜電，安全上沒有問題。 → 介意的話，建議實施接地。 (P. 9頁)
<p>電視機・收音機等發生有雜音・映像的花亂</p>	<ul style="list-style-type: none"> ● 是從電冰箱發出的微弱電磁波的影響。 → 請離開電視機・收音機・電話門鈴等設置。 → 建議在離開天線等的地方接電源，實施接地。 (P. 9頁)
<p>塑膠零件上有像傷痕一樣的細線</p>	<ul style="list-style-type: none"> ● 是塑膠成型時發生的樹脂流痕。 透明的部件會特別顯眼，強度上沒有問題，不會至於破裂。
<p>箱門面或側面・頂面上有波紋或歪扭</p>	<ul style="list-style-type: none"> ● 冰箱的製造工程上，會發生有輕微的波紋或歪扭。 根據照射方向及亮度等會感到顯眼，但性能上沒有問題。
<p>冷藏室門操作面板的顯示燈熄滅</p>	<ul style="list-style-type: none"> ● 操作結束後，經過約 2 分鐘文字顯示燈則熄滅。但是急冷運轉的顯示以及 eco 運轉顯示燈則亮燈。如果要讓其亮燈時請按任何一個按鍵。
<p>箱門內側有小的洞</p>	<ul style="list-style-type: none"> ● 這個洞是在冰箱製造過程中，填充絕緣材料時為了讓內部的空氣往外散所挖的洞。不是損傷也不是異常情形。

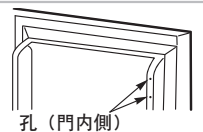

這種情況下 / 另購零件

冷藏室門操作面板的「確認」顯示閃爍

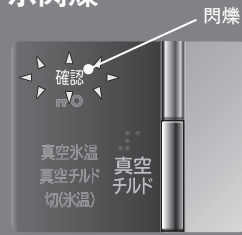

- 是通知自動製冰機、溫度控制或除霜裝置等有異常。
- 請確認下表的内容。閃爍還是不停的時候，請與經銷店洽商。

顯示閃爍模式	可考慮到的原因	請確認
確認	「確認」閃爍 3 次	製冰盤及儲冰量測知桿上，有食品等觸碰著的可能。
	「確認」閃爍 (除了閃爍 3 次)	告知有異常。
真空	「真空開 +1°C」或「真空開 -1°C」閃爍	真空機能有可能不是在正常運作。
		有可能是設定在工作人員確認運轉用的式樣。(※1)
製冰	「大顆」「標準」「停止」閃爍	正在進行「製冰機清潔」。
	「停止」閃爍	在製冰中途製冰「停止」時會閃爍。
全部的顯示閃爍。	箱門敞開了 1 分鐘以上的狀態。(門沒關緊等)	請確認 P.30 的「箱門警報器」。

※1 長時間 (10 秒鐘以上) 碰觸同一個鍵鈕時，可能會成為確認運轉用的式樣。

停電了

- 在到恢復之間，請減少箱門的開閉，避免重新再存放食品。

長時間不用

- 拔下電源插頭，清掃庫內及自動製冰機，所有的門打開乾燥 2 ~ 3 天。 (P.21~23頁)

除霜

- 此電冰箱自動除霜，不需要操作。溶解了的水會積在蒸發盤上，自動蒸發。

想更詳細調節溫度時

- 冷藏室和冷凍室的溫度設定可以調節更微細的「強」「中」「弱」。
1. 打開冷凍室下層的門。
 2. 按住冷藏室門操作面板的冷藏鍵 5 秒以上，直至發出「嗶-」聲。(可以進行細微調節。)
 3. 按冷藏、冷凍鍵調節。每按一次增強一段。(在「強」時按，則回復為「弱」。)
 4. 想停止微細調節時，請進行 1 和 2 的操作。警報音「嗶嗶」響起便回復為通常的調節。

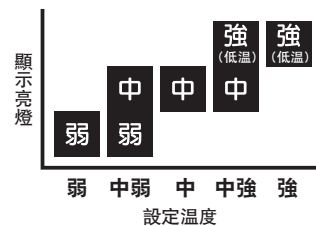

另購零件

以下零件交換時，請務必向經銷店指明型號名，購買專用的零件。

淨水濾片的更換

- 舊了請更換。(基本上是約 3 ~ 4 年)
- 訂購更換用的淨水濾片
請指定零件型號：RJK-30，向經銷店購買。
(拆去淨水濾片製冰能力也不會改變。)

更換真空密封墊

- 密封墊破損時請更換。
- 更換零件的訂購

	零件編號
R-S51AMJ 型	R-S50AM 321

遇到問題時 / 這種情況下 / 另購零件

[eco 運轉顯示燈] / 箱門警報器 / 操作面板鎖定

[eco 運轉顯示燈]

自動告知冰箱的運轉狀況。霜循環冷卻時，減少電力消耗，啟動運轉時則顯示燈亮燈。



夜間等特別在意亮燈時，可以將 [eco 運轉顯示燈] 熄滅。

■將顯示燈熄滅的方法

持續按住真空開 +1°C 按鈕約 3 秒，直到 [eco 運轉顯示燈] 閃爍為止。



此時 [eco 運轉顯示燈] 則熄滅，完成設定。

通知事項

- eco 運轉顯示燈無法亮燈時，可能是以下的原因。
 - eco 運轉顯示燈是否設定為顯示燈熄滅的模式呢？→請依照上面的說明操作回復原來設定的方法。
 - 一次存放太多的食品、或是冰箱門開閉的次數過於頻繁以致壓縮機進行高速運轉，所以顯示燈無法亮燈。→請盡可能冰箱開閉時間勿過久、及減少開閉次數。
 - 急冷功能（“急冷凍”、“急冷藏”）正在運轉時→運轉結束後冰箱的運轉在安定的情況下，顯示燈亮燈。
- 當拔除電源插頭再插上插頭時，或停電後恢復供電時，eco 運轉顯示燈則恢復到原來的設定。



■回復到原來設定的方法

持續按住真空開 +1°C 按鈕約 3 秒，直到 [eco 運轉顯示燈] 亮燈為止。



此時 [eco 運轉顯示燈] 則亮燈，完成解除設定。此時會因運轉情形時而亮燈，時而熄滅。



箱門警報器

箱門的敞開狀態超過 1 分鐘以上，便會發出如下表所示的警報音與 LED 顯示燈的閃爍，以聲音與亮光告知箱門開著。

箱門的敞開時間	警報音	冷藏室門操作面板
1 分鐘後	嗶—嗶—嗶—	閃爍
2 分鐘後	嗶—嗶—嗶—嗶—嗶—	閃爍
3 分鐘以後	連續不停響	閃爍

箱門警報機能是附屬於冷藏室・製冰室・下層冷凍室。
(上層冷凍室・蔬果保鮮室無此機能)

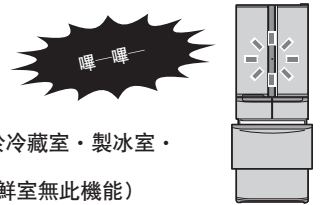

可以停止箱門警報

■停止警報器時

按住急速冷凍鍵約 3 秒，直到“嗶嗶”聲響。



警示音停止則回復到最初的顯示。

通知事項

- 將冰箱門警報音關掉後，冷藏室門操作面板的文字顯示燈的閃爍也停止。此外，操作音也停止。
- 一開始安裝時，冰箱門警報音室設定在會發出聲音的狀態。
- 當拔除電源插頭再插上插頭時，或停電後恢復供電時，冰箱門警報音則恢復到原來的設定。

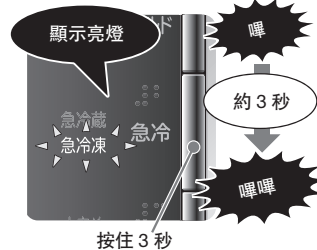

■再次使警報器響時

按住急速冷凍鍵約 3 秒，直到“嗶嗶”聲響。



設定完了後則回復到最初的顯示。

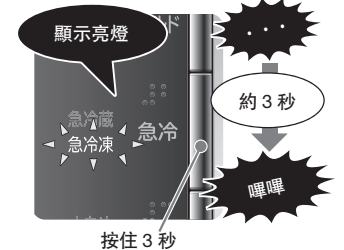

操作面板鎖定功能的設定

⏸ (操作部鎖定) 的顯示燈亮燈時，按了其他的按鈕也無法操作。是為了防止誤觸冷藏室門操作面板，及兒童亂弄冰箱所設計的功能。

持續按住冷藏按鈕約 3 秒以上，直到發出嗶 嗶聲響時，可以選擇操作部鎖定功能的「設定」或「解除」。

通知事項

- 設定後請再確認冰箱的溫度設定。

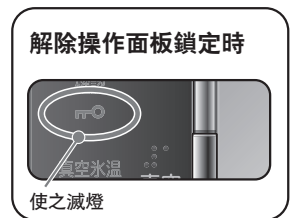
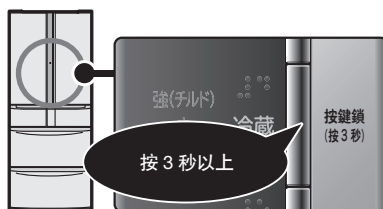

CONTENTS

BEFORE USE

- **SAFETY SUGGESTIONS** 32
- **BEFORE USE** 36
 - Installation Place 36
 - Clearance around the refrigerator 36
 - Adjusting the refrigerator adjustable mount to keep it level 36
 - On the Power Plug and Grounding 37
 - Storing foods 37
- **CONTROL PANEL/NAME OF EACH COMPARTMENT/STORAGE COMPARTMENT** 38
 - Control Panel for operation 38
 - Name of each compartment 39
 - Foods which are suitable for storage in the Vacuum Compartment 39

GENERAL USE

- **REFRIGERATOR COMPARTMENT** 40
 - Adjust the temperature of the refrigerator compartment 40
 - Quick Cooling (When cooling food quickly) 40
 - Multiuse Egg Case (this case can be put in the Refrigerator Compartment with eggs in it) 41
 - Shelves and pockets are adjustable 41
- **VACUUM COMPARTMENT** 42
 - Preparation before use 42
 - When opening/closing the door of the Vacuum Compartment 42
 - How to maintain/care the Vacuum Compartment... 43
 - How to maintain/care the Vacuum Compartment with the vacuum packing removed 43
- **FREEZER COMPARTMENT** 44
 - Upper Freezer / Lower Freezer 44
 - Height of the storageable food 44
 - Adjust the temperature of the freezer compartment 45
 - Quick Freezing 45
- **ICE COMPARTMENT (AUTOMATIC ICE MAKER)** 46
 - How to make Ice 46
 - How to change the Settings of the Automatic ice maker 47
 - When you want to make ice quickly (Quick Ice Making) 47
 - Ice making time and capacity 47
- **VEGETABLE COMPARTMENT** 48
 - Lower Case/Spacious Upper Case 48

HOW TO MAINTAIN

- **HOW TO MAINTAIN/HOW TO CARE THE INNER · OUTER OF THE REFRIGERATOR** 49
 - When dirt is found 49
 - Power Plug 49
 - How to care the inner · outer of the refrigerator .. 49
- **HOW TO REMOVE PARTS** 50
- **HOW TO MAINTAIN THE AUTOMATIC ICE MAKER** 51
 - Ice Maker Cleaning 51
 - Water supply container / Water filter 51
 - Ice tray 51

TROUBLESHOOTING

- **TROUBLESHOOTING** 52
 - FAQ when using for the first time 52
 - Control Panel does not respond 52
 - Automatic ice making is not properly performed 52
 - Refrigerator does not cool 53
 - Frost and/or dew occur 53
 - Refrigerator cools overly 53
 - Abnormal operating sound is generated 54
 - The refrigerator becomes hot 54
 - There is something strange with the Vacuum Compartment 55
 - It smells strange 56
 - Door is not in a horizontal state 56
 - Others 56
- **PRACTICAL ADVICE ON HOW TO USE THE REFRIGERATOR/REPLACEMENT PARTS** 57
- **["eco" OPERATION INDICATOR LAMP]/DOOR ALARM/LOCK FUNCTION OF THE PANEL FOR OPERATION** 58
- **ABOUT NON-CFC REFRIGERATORS/ SPECIFICATION/STORABLE WEIGHT** 59

SAFETY SUGGESTIONS

Ensure to follow these precautions

When using this appliance, failure to follow safety precautions may result in personal harm, harm to other people, and also damage to property.

■ The following pictographs categorize and explain the level of possible harm or damage that may occur from ignoring suggestions resulting in missing the appliances.

■ How the suggestions should be taken are indicated and categorized by the following symbols accompanied by explanations. (The symbols below are examples)

	WARNING	Suggestions headed by this pictograph indicate "There is high chance of serious injury or death" if ignored.
	CAUTION	Suggestions headed by this pictograph indicate "There is a high chance of injury or damage to property" if ignored.

	This symbol indicates something you must not do. (Prohibited)
	This symbol indicates something you must do. (Compulsory)

WARNING

Installation

- Install earth leakage circuit breaker when installing the refrigerator in a humid or damp environment.**
 Electrical leakage due to failure, etc. could result in electrical shock.
 - Make sure to contact the dealer for earthing installation. Pg.37
- Do not install the refrigerator in damp places or where water may splash on.**
 This may impair electricity insulation causing electric shock or fire.
- Take measures to prevent overturning of refrigerator due to earthquake, etc.**
 Overturning of the refrigerator could result in personal injury. Pg.37

Handling the power and power cable

- Avoid usage that may cause the wall outlet or power cord components to work beyond the specified voltage. Also do not use power sources that are not a rated voltage current.**
 If a power source is shared with other appliances, double or multipoint adapters may heat up beyond normal levels and cause fire.
 - Use a wall outlet rated above 15 ampere by itself.
- Do not do anything that may damage the power cord or plug.**
 The power cord or plug should not be cut, modified, touched with hot implements, bent by force, twisted, pulled, have heavy objects placed on it, squeezed by the refrigerator, or be bound or tied up.

 Using a damaged power cord may cause electric shock, short circuits, or fire.
 - Please consult with a retailer about the repair of the power cord or plug.
- Connect the power plug firmly to a power outlet with the cord running down.**
 Connection of the power plug with the cord running up could apply stress on the cord and cause electrical short or overheat, which could result in electrical shock or fire.
 - Incomplete connection of the power plug could result in electrical shock or fire due to heat.
- Do not insert or remove the power plug with wet hands.**
 This may result in electric shock.

⚠ WARNING

Handling the power and power cable



- **Clean the dust on the power plug frequently.**
Insulation failure from moisture when dust collects on the power plug may cause fire.

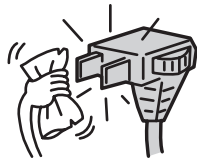

- **Be sure to unplug the power plug before maintaining the refrigerator.**

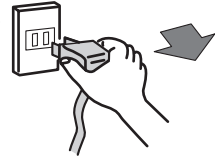

Continued use may cause electric shock or injury. Pg.49

- Always hold the plug when unplugging it.

During normal use



Wetting Prohibited

- **Do not splash water on or inside the refrigerator.**

- This may impair electricity insulation causing electric shock or fire.



Prohibited

- **Do not put in things that may catch fire.**

- Benzine, ether, LP gas, thinner, adhesives may ignite an explosion.



Wetting Prohibited

- **Do not put water containers on the refrigerator.**

- Spilled water may impair insulation of electrical components causing faulty electrical currents. This may result in electric shock or fire.



Prohibited

- **Do not use flammable sprays near the refrigerator.**

- Sparks from points of electrical contact such as door switches may ignite a fire.



Prohibited

- **Do not put things on top of the refrigerator.**

- Opening and closing doors etc. may cause things placed on top of the refrigerator to fall resulting in injury.



Prohibited

- **Drugs, chemicals, research and experimental substances should not be stored in the refrigerator.**

- Substances that require precise conditions for storage cannot be stored in a domestic refrigerator.



Contact Prohibited

- **Do not touch the machinery components of the Automatic ice maker.**

- There is a danger of injury when the ice trays are rotating.



Prohibited

- **Do not hang on the doors or step up on the various compartments.**

- Injury may be caused by the refrigerator tipping over or hands getting caught between doors.



- **Children should be supervised to ensure that they do not play with the appliance.**



Prohibited

- **Do not remove the cover of the interior light.**

- When the interior light is damaged, please contact either the manufacturer, the service centre or person with required knowledge for replacing the light to avoid injury.

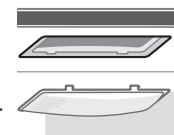

⚠ WARNING

Concerning the refrigerant (Be careful of the following related to the use of flammable gas.)



Prohibited

- Do not scratch or damage the main body of the refrigerator with a sharp object such as a screw.



Since the refrigerant used is flammable, any leakage from the pipe inside the wall may cause ignition and explosion.



- Allow clearance around the refrigerator and keep ventilation openings when installing it.

 Pg.36

Leakage of the refrigerant may accumulate and cause ignition and explosion.

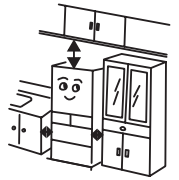

- Do not damage the refrigerant circuit. If you happen to damage the refrigerant pipe, stay away from the refrigerator and avoid using fire and electrical appliances.

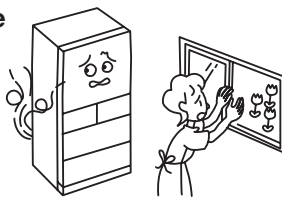

Should you damage the refrigerator, open the window to ventilate and contact your dealer or our repair reception desk.



- Please consult your dealer or the Recycle Hotline (0800-085-717) of the Recycle Centers in the Environmental Protection Administration when discarding the unit.

If the refrigerant is wet, it may cause ignition and explosion.



Prohibited

- Do not use mechanical devices or other means to accelerate the defrosting process, other than those recommended by the manufacturer.

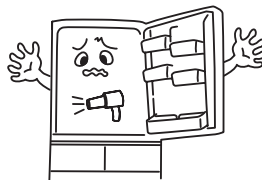

Prohibited

- Do not use electrical appliances inside the refrigerator.

• If the refrigerant leaks, sparks on the contact may cause ignition and explosion.

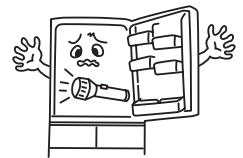

In case of emergency



- Stop the refrigerator by unplugging it if it is not running properly or broken.

Continue may cause electric shock or injury.

• Always hold the plug when unplugging it.

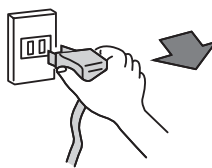

Disassembly prohibited

- Do not disassemble, repair, or modify your refrigerator.

Injury may be caused by ignition of fire or faulty running.

• Please consult with a retailer if any repairs or disassembly are required.



- In the event of a flammable gas leak do not touch refrigerator and open windows to let air flow.

• Sparks from points of electrical contact such as door switches may ignite explosions causing fire or burn injuries.



When discarding the unit



- Before discarding the unit or recycle, remove the door packing to avoid the risk of an infant or children to be entrapped inside.



CAUTION

Handling the power and power cable



Prohibited

- **On a floor that is easily scratched do not move the refrigerator using the wheels at its base.**

The wheels may scratch the floor.

- For a floor that may be easily scratched, lay a protective mat.

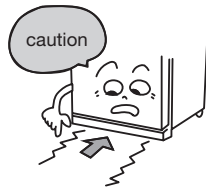

- **Use the carrying handle when carrying it.**

Your hands may slip resulting in injury if you hold the refrigerator in other places apart from at the carry handles.

- More than 2 person should carry the refrigerator for safety reasons.
- Carry it with the door facing upward; as shown in the illustration.
- Never hang the handle with a crane.



During normal use



Prohibited

- **Do not put bottles in the Door Baskets if they do not sit properly on the bottom of the front section.**

- Forcing in items like large bottles may result in them getting tipped over, causing injury.



Prohibited

- **Do not have food items protruding over the front of the shelves.**

- Injury may be caused from items like bottles getting knocked over.



Prohibited

- **Do not put the glass bottles in the Freezer Compartment.**

- Bottles may break from the contents freezing and cause injury.

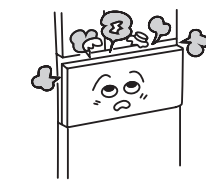

- **When two or more doors are being opened or another person is using the refrigerator, make sure fingers don't get caught.**

- Fingers may get caught in the spaces between doors causing injury.



Prohibited

- **Do not hold the top of the doors when closing them.**

- If you hold the top of a door when closing it you may get your fingers caught or pinched causing injury.

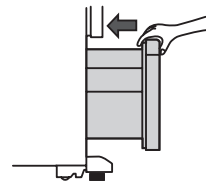

Prohibited

- **Foods and containers inside the Freezer Compartment should not be touched with wet hands.**

- This may cause frost injury. (Especially in the case of metal items)



Prohibited

- **Do not have your feet too close when opening the bottom door of the refrigerator.**

- When opening this door you may hit the in step or other parts of your feet resulting in injury.



Prohibited

- **Do not eat food that smells strange or has changed color.**

- Bad foods may cause serious sickness.



Prohibited

- **Do not put your hands or feet under the base surface of the refrigerator.** When cleaning, putting your hands under the base surface of the refrigerator may result in injury by cutting them on sheet metal parts.

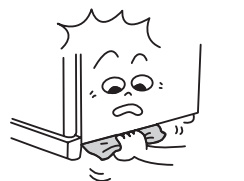

BEFORE USE

1 Installation Place

- The floor should be sturdy and flat.

Lay the board which has 1cm thickness on the floor if the refrigerator is installed on the carpet, tatami mat, flooring or PVC sheet flooring which may hollow or discolor.

- A location away from direct sunlight and heat is recommended.
- A location is not damp and has good air flow.

This will reduce adverse effects to refrigerating power and keep electricity cost down. This will also prevent the refrigerator from discoloring and rusting.

2 Clearance around the refrigerator

- To cool efficiently, allow enough space around the refrigerator for radiating heat.

- The actual size of the center part of the side of the refrigerator's main body is slightly larger than the nominal size. Therefore, allow enough space around the refrigerator taking it into consideration when installing the refrigerator.

- The back of the refrigerator can be placed very close to a wall. If any vibration sound occurs and/or any discolor/dirt is found on the wall, move the refrigerator away from the wall.

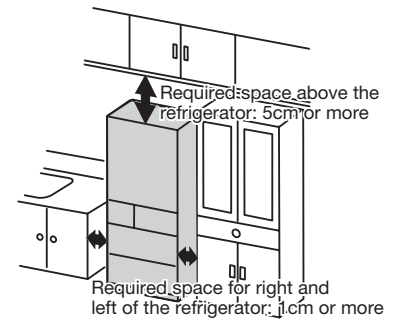

3 Adjusting the refrigerator adjustable mount to keep it level

- Left side or right side of the door may be slightly lower when the surface of the installation place is not level or either of the left and right leg is sunk in the floor surface because of the soft floor material and the addition of food weight.

→ This does not affect the refrigerator function. Adjust the refrigerator adjustable mount to keep it level according to the procedure listed below if you want to correct it.

Correcting any left/right lean and lifting slightly the front side of the refrigerator, the door can close easily and completely.

- 1 To remove leg cover, hold both ends of it and pull it towards to you applying some force.**

- 2 Turn both Adjustable mounts to lower them to the floor surface and fix them. (2 mounts: left & right)**

- 3 Turn left and/or right Adjustable mounts to make the Refrigerator Compartment Door horizontal.**

- The height of the door will change by 1mm every 1 turn of Adjustable mount.
- The adjusted door may lean because it may take several days until the refrigerator permanently becomes level after adjusting. Adjust the refrigerator legs again to keep it level according to the procedure if this is the case.
- Use the optional parts "Door Adjusting Plate" (Parts No. R-Y6000 500) if the door still leans after that. Contact your dealer for details.

- 4 Insert the left and right pins of the leg cover into the leg holes to install the leg cover.**

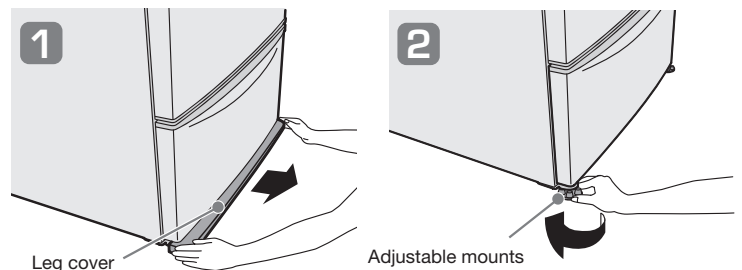

- The left side of the door is lower.

- The right side of the door is lower.

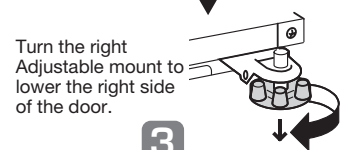
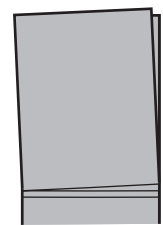
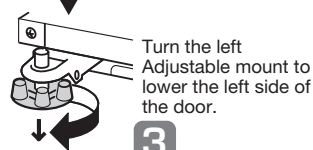
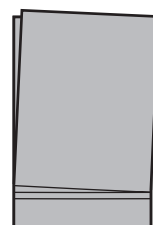

- When it is hard to turn the Adjustable mount push and turn it with a tool such as a driver.

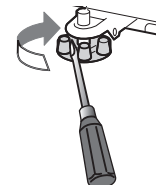

4 On the Power Plug and Grounding

- It is not a problem to plug in the power cord soon after installing the refrigerator.
- Use a wall outlet exclusively when connecting the power cord. (Alternating current 110V, rated 15A or more)

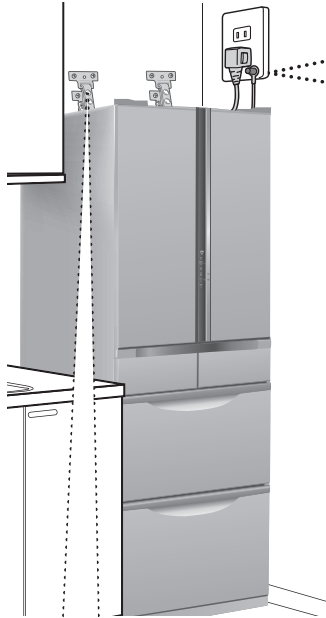

It is recommended to ground the refrigerator to prevent possible electrical shock.

- Contact your dealer to ground the refrigerator or install an earth leakage circuit breaker if the refrigerator is installed in especially damp and humid places.
- Option: "Earth wire (2.5m)" (Parts No. NW-60R6 052)

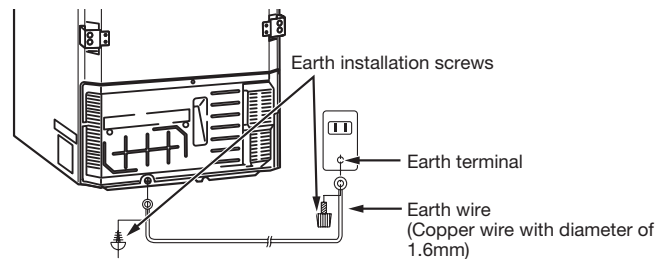

Never connect the earth wire to the following places:

- Water pipe (Danger of electrical shock)
- Gas pipe (Danger of explosion)
- Telephone line or earth of lightning rod (Danger when lightning strikes)

Preparation for an earthquake has been made properly?

- It is recommended to fix the refrigerator to a sturdy wall or pillar using two "safety belt against overturning for refrigerators".
- Option: "Safety belt against overturning for refrigerators" (Parts No. R-826CV 300: belt x 1) Contact your dealer for details.

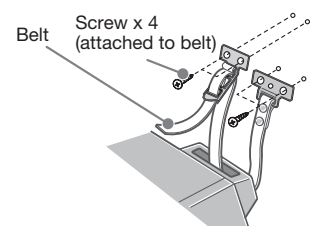

5 Storing foods

- Do not put the ice cream, foods that are not cooled well or perishable foods in the refrigerator before the inside of the refrigerator cools fully.
- It may take more than 4 hours through 24 hours to cool well the inside of the refrigerator, depending on conditions such as the ambient temperature or the storage state of foods.
- Perform “製冰機清潔” (Ice Maker Cleaning) when using the automatic ice making function first. [Pg.51](#)
- A series of ice making operation will start automatically after the inside of the refrigerator is cooled well. (When using for the first time, it may take 24 hours and more to make ice.)
- Minimize the number of times of opening and closing the door.
- Allow clearance between each food.
- It may smell like plastic for the first time. Ventilate the room well to make sure that the room is not filled with the smell. The smell gradually disappears.
- Wrap foods such as fish/meat or foods that have a strong flavor in polyethylene film, etc. or keep them in a sealed container.

Notice

- Do not remove the sticker from the back of the refrigerator. This sticker is necessary to secure the performance and safety.
- Do not remove the plastic parts and label from the bottom part of the side of the refrigerator.

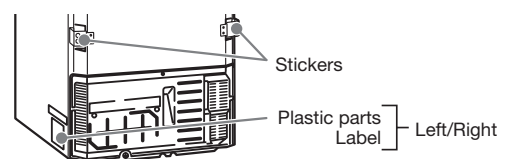

※ If you wish to install the refrigerator in a hot spring area exposed to sulfide gas, you may need to apply anti-rust treatment to the piping. Contact your dealer in advance. Failure caused by gas damage will not be covered under guarantee.

CONTROL PANEL/NAME OF EACH COMPARTMENT/STORAGE COMPARTMENT

Control Panel for operation

- Control Panel Image (It is an image when all displays are turned on. Only the selected character display is turned on when actually operating it.)
(Quick Cooling) operation and eco operation indicator lamps will not be turned off.
In order to check the setting, push either button. The indicator lamp will be illuminated again.



Useful Function

Vacuum Compartment	Push the “真空チルド” button to select "Vacuum Compartment Subzero", "Vacuum Compartment Chiller" or "OFF". (Pg.42) It is set to “Vacuum Compartment Subzero” according to the factory default.
Quick Cool Functions	Push the “急冷” button to select "Quick Freezing", "Quick Cooling" or "Quick Freezing and Quick Cooling".
Quick Freezing	Freezer Compartment is strongly cooled. Select it when you want to freeze the food etc. quickly. (Pg.45)
Quick Cooling	Refrigerator Compartment is strongly cooled. Select it when you want to cool food and/or drink quickly. (Pg.40)
Quick Freezing and Quick Cooling	Freezer Compartment and Refrigerator Compartment are strongly cooled. Cooling effect is weaker than when "Quick Freezing" or "Quick Cooling" is selected.
Ice Making	Push the button to select the ice size of "Normal" or "Large". (Pg.47) Select "Stop" when you don't need to use the Automatic Ice Maker.
Cleaning the Ice Maker	Ice Tray and Water Supply Line can be washed by pushing the “製氷” button for more than 5 seconds. (Pg.51)
["eco" Operation indicator lamp]	Indicates the operation mode of the refrigerator. The indicator lamp can be turned off. (Pg.58)
Check	“確認” (Check) flashes when there is a malfunction. (Pg.57)
Button Lock	Push the “冷蔵” button for more than 3 seconds to display (Button Lock display) when you want to prevent the operational error of the Control Panel. (Pg.58)

Adjusting the temperature

Refrigerator Compartment	Push the “冷蔵” button to set the temperature of the Refrigerator Compartment. (Pg.40) Select “中” (Mid) in ordinary usage.
Freezer Compartment	Push the “冷凍” button to set the temperature of the Freezer Compartment. (Pg.45) Select “中” (Mid) in ordinary usage.

Notice

- Operate it with all the doors closed. The Control Panel doesn't respond in order to prevent improper operation while the Refrigerator Compartment Door is opened, even if the characters are displayed, when the Control Panel on the Refrigerator Compartment Door is pressed.
- All the displayed characters on the Control Panel on the Refrigerator Compartment Door flash if the door remains open for 1 minute and more (Door Alarm). (Pg.58)

Name of each compartment

Refrigerator compartment (About 2°C ~ 6°C)

 Pg.40 **Refrigerating foods**
The temperature of door pocket is slightly high.

Ice compartment (About -20°C ~ -18°C)

 Pg.46
Store the ice cube made by auto ice making function.

Vegetable compartment (About 3°C ~ 7°C)

 Pg.48
Vegetable, fruits, drink

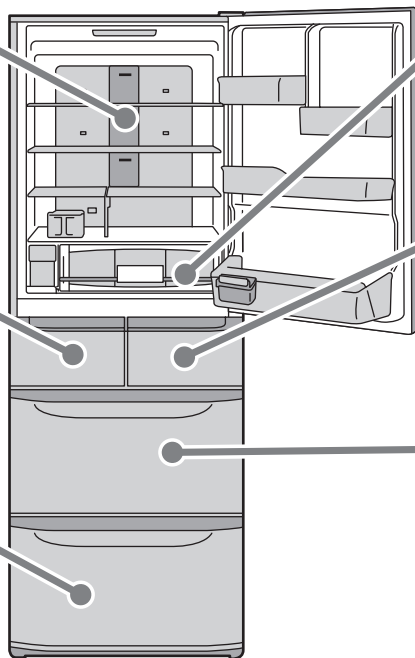



Vacuum compartment (About -1°C ~ 1°C)

 Pg.42
Foods which are suitable for storage are as shown below.

Upper freezer (About -20°C ~ -18°C)

 Pg.44
Store frozen foods, ice-cream and dried foods.

Lower freezer (About -20°C ~ -18°C)

 Pg.44
Store frozen foods, ice-cream and dried foods.
• **Low Temperature Freezer**  Pg.45
(About -23°C ~ -20°C)
Foods are preserved at lower temperature than usual.

Foods which are suitable for storage in the Vacuum Compartment

Vacuum Compartment Chiller

Vegetable salad, dairy products, meat and fish are preserved while the vacuum power plus antioxidant vitamin prevent natural nutrients in the foods from getting oxidized.

● Vegetables, fruits



Vegetable salad, bell pepper, apple, orange, kiwi etc.

● Others

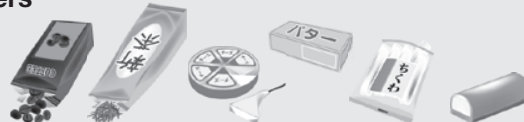

Coffee bean, tea, dairy product, paste etc.

More suited for meat and fish storage because the temperature is lower than that of the Vacuum Compartment. Other foods may be frozen or change its nature. It is recommended to store meat and fish only.

● Meat, processed meat



Beef, pork, poultry, ham, sausage etc.

● Fish, seafood



Horse mackerel, sardine, mackerel, fish roe etc.

Vacuum Compartment Subzero

“切” (Off)
“氷温” (Subzero)
(About -1°C)

The vacuum function will not work. It is recommended to store a “sealed bag” or a “sealed container” which needs some care. This is an ordinal ice-temperature compartment, so some foods may be frozen.

Food and container for which care needs to be taken during storage

● Food contained in a sealed bag

The bag may be inflated during storage, which could result in crushing of other stored foods.



Vienna sausage, sliced cheese etc.

Caution

● Plastic airtight container

The lid of the container may become loose or may not stay in place during storage. Be careful when you take out the container.



Caution

Food which are not suitable for storage

● Vegetable sensitive to low temperature

The surface of the vegetable may deteriorate due to low temperature.

● Do not select “Vacuum Compartment Subzero” and “OFF” when storing the food other than meat, fish and processed meat/fish. Juicy food such as vegetable and bean curd may freeze.



Eggplant

Cucumber

The temperature is used as a guide when the temperature is stable under the condition that no food is stored with the door closed (ambient temperature: 30°C). The vibration may get larger, because the compressor operates at low speed when the door is not opened or closed for a long time such as at night or during someone is away.

REFRIGERATOR COMPARTMENT

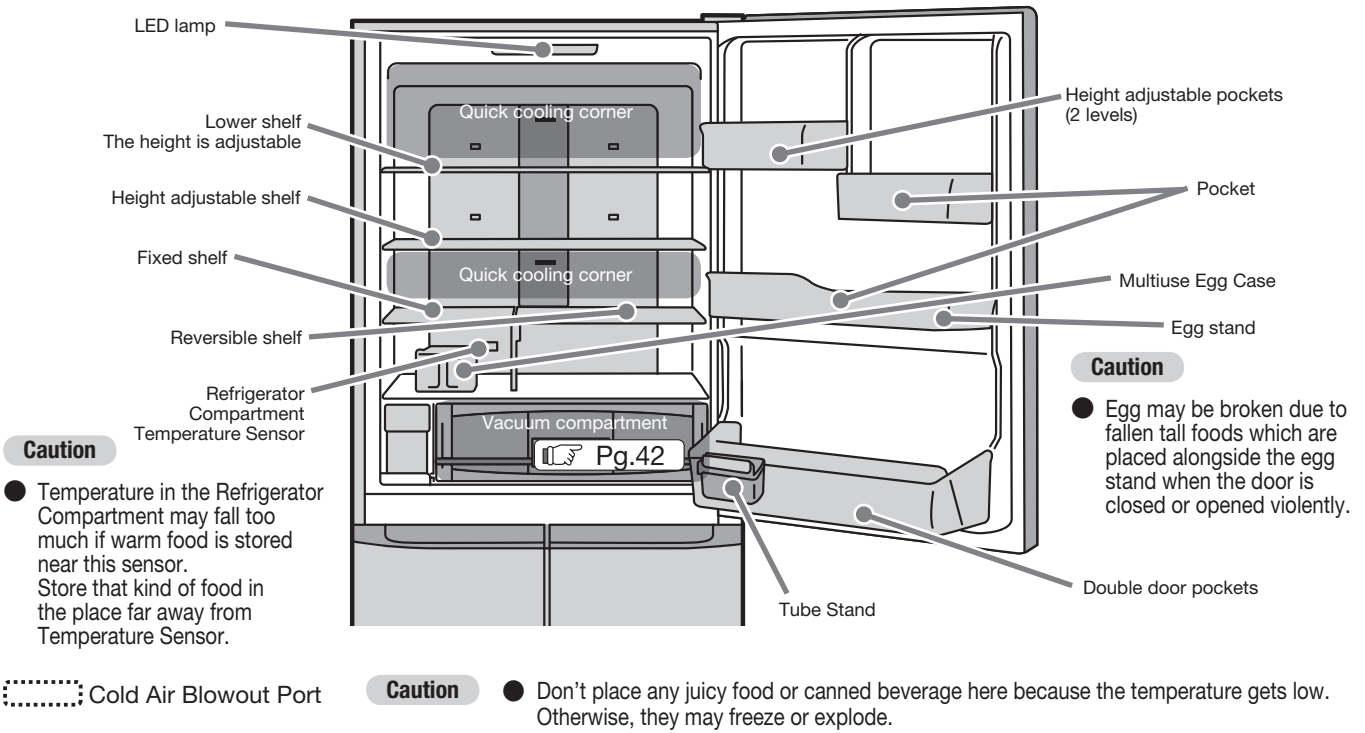

⋯ Cold Air Blowout Port

Adjust the temperature of the refrigerator compartment

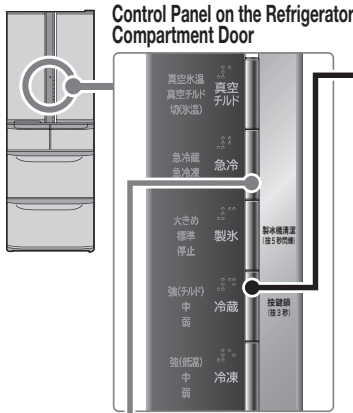

Adjust the temperature of the refrigerator compartment

Push the “冷蔵” button to adjust the temperature of the refrigerator compartment.

The temperatures are standard values under the specific condition (the surrounding temperature of 30°C, no food stored, door closed and the temperature in the refrigerator is steady).

強 (低温)	About 1 ~ 3°C lower than “中”
中	About 2 ~ 6°C
弱	About 1 ~ 3°C higher than “中”

- Select “中” in ordinary usage. The temperature may change depending on the operation states.
- The temperatures of the Vacuum Compartment also change if selecting “強 (低温)” or “弱”.
- Temperature of the door pocket is set slightly higher than the one in the left table.

- Notice**
- The displayed character will disappear about 2 minutes after the operation finishes. However, “急冷” (Quick Cooling Operation) or “eco” operation indicator lamp will not be turned off.
 - For more information about the panel for operation. (Pg.38)
 - If you adjust the temperature more finely. (Pg.57)

Quick Cooling (When cooling food quickly)

1 Place the foods in the Quick Cooling Corner (upper shelf).

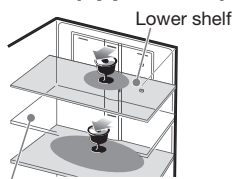

Height adjustable pockets

- The food cools more quickly if it is placed on the center part near the interior wall. (the front of the Cold Air Blowout Port)
- Place any juicy food and/or canned beverage on the place far from the interior wall or move them to the Lower Shelf. Otherwise, they may freeze or explode.

Notice

- Cooling effect may become weaker depending on the operation states of the refrigerator when simultaneously using this function and Quick Freezing (Pg.45) function.

2 Push the “急冷” button to display “Quick Cooling”. ※



※ Indicators other than “急冷” (Quick Cooling Operation) will be turned off about 2 minutes after setting the “急冷” (Quick Cooling Operation).

3 “Quick Cooling Operation” ends automatically after about 45 minutes.

The indicator lamp will be illuminated during the “急冷” (Quick Cooling Operation). Other indicator lamps are turned off ※



Push the “急冷” button to turn off the display after turning on other displays again, when you want to stop this function.



Multiuse Egg Case (this case can be put in the Refrigerator Compartment with eggs in it)

Multiuse Egg Case

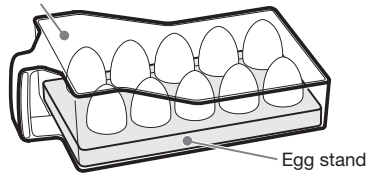

Ten eggs can be stored in this case.
The egg pack with eggs in it can be stored as it is.

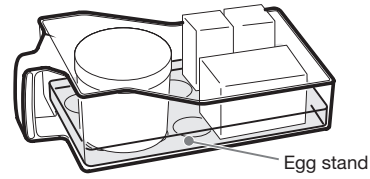

When the egg stand is turned over, it can be used for small sized food.

Caution

- Hold the carry handle securely when handling it.
- Do not stack foods, or otherwise they may drop.
- Do not put tall foods in because they may fall down.
- Do not make ice with this container.
- Do not put the Multiuse Egg Case in the Descendible Case.

Shelves and pockets are adjustable

Shelves and pockets position can be adjusted according to the size of food and drinks.
Remove the stored items before adjusting the shelves.

■ Height Adjustable Shelf · Lower Shelf

- 1 Remove by slightly lift up the back of the shelf and pull forward.
- 2 Adjust the shelf to the desired height and slide it until it reaches to the interior wall, then slightly lift up the back of the shelf and push it in.
(Hitch the forks of the shelf to the parts on the back of the shelf)

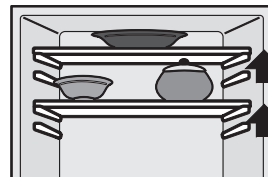
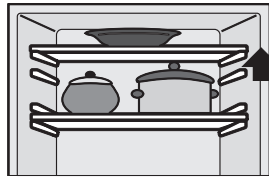
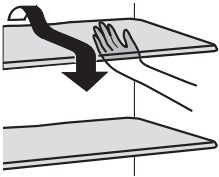

■ Reversible Shelf

- 1 Remove by slightly lift up the shelf.
- 2 Turn over and set at either top or bottom level.

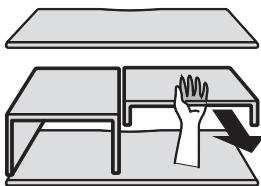

As a normal shelf

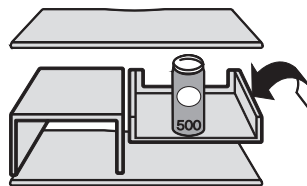

Pattern 1

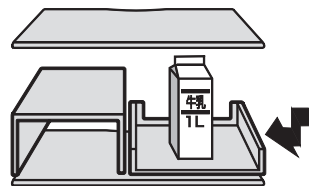

Pattern 2

■ Height Adjustable Pockets (Right) (Left)

It can be adjusted to the desired height.

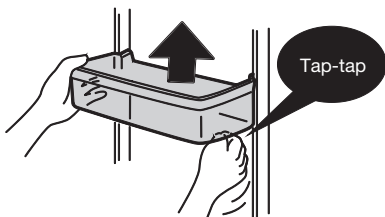

■ Tube Stand

Small things can be placed vertically in a neat manner.
Hang it on the edge of each pocket as you like.

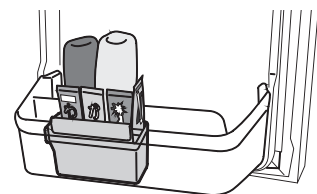
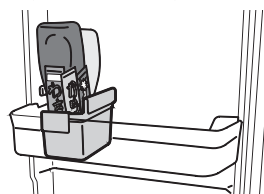

Caution

- Do not hang it outside the door pocket.
When closing the door, the door, the case or foods may get damaged.

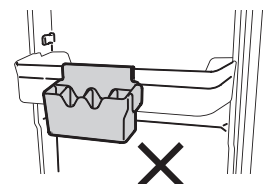

VACUUM COMPARTMENT

- Seals the Vacuum Compartment, and lowers the air pressure inside the case into the vacuum state (under low-oxygen conditions) by using the vacuum pump. Vitamin Case helps to suppress oxidization of foods.
- The natural nutrients and good flavor in the foods are preserved in a longer period than before due to suppression of oxidization.
- The vacuum effect will not change even if foods are wrapped.

Note: The word "vacuum" used here means the space where the air pressure inside is lower than the atmospheric pressure. The air pressure in the Vacuum Compartment is approximately 0.8 atm, which is lower than the atmospheric pressure, so we call such state as vacuum.

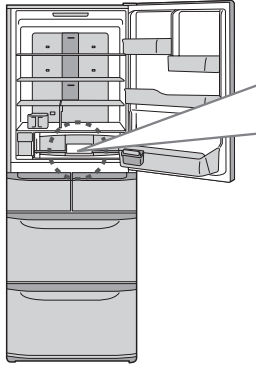

Vitamin Case (on the ceiling inside the Vacuum Compartment)

This lets out vitamin to preserve natural nutrients in the foods for a longer period under low-oxygen conditions.

Vacuum Container

Handle

Use this handle from beneath to open or close.



Vacuum release valve (in blue)

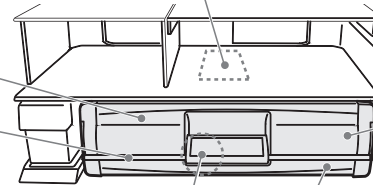

Vacuum Case (with the door)

Toothed wheel (Under the case inside the compartment)

Raise the handle to unlock it. The vacuum will be released by the vacuum release valve.

Hissing sound is generated when releasing the vacuum.

Notice

- Sound or vibration occurs when the vacuum pump starts to run in order to lower the air pressure inside the Vacuum Compartment. Such operating sound or vibration is not abnormal.
- The vacuum pump operates after the door of the Vacuum Compartment is locked and the door of the Refrigerator Compartment is closed. It takes about 3 minutes to achieve the vacuum state after the vacuum pump starts the operation. If the door is opened before 3 minutes pass, no hissing sound may be generated. Check the vacuum state after 3 minutes and more.

Caution

- The Vitamin Case needs no replacement on regular basis. Do not remove it.

Preparation before use

- Display "Vacuum Compartment Subzero" or "Vacuum Compartment Chiller" on the Control Panel for operation to use this function.

※ It is also available as a normal Ice Compartment (-1°C) by selecting "OFF". [Pg.38](#)

To be used as a guide under the conditions that the ambient temperature is 30°C and is stable.

Vacuum Compartment Chiller

About +1°C
(Vegetables, dairy products, meat, fish, etc.)

Vacuum Compartment Chiller display ON For more information.

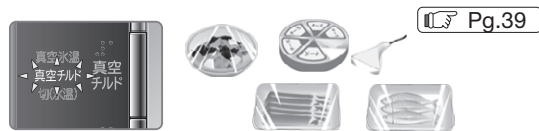

[Pg.39](#)

Vacuum Compartment Subzero

About -1°C
(Especially for preserving meat, fish, and processed meat/fish)

Vacuum Compartment Subzero display ON



Caution

- Juicy foods may be frozen because it is preserved at the temperature lower than "Vacuum Compartment Chiller".

Notice

- The displayed characters will disappear about 2 minutes after the operation finishes. However, "急冷" (Quick Cooling) and "eco" operation indicator lamps will not be turned off. Push either button to check the setting. The indicator lamp will be turned on again.
- The displayed character will be changed from "真空開 +1°C" (Vacuum Compartment Chiller) → "真空開 -1°C" (Vacuum Compartment Subzero) → "真空開 -1°C" (OFF) (Subzero) in turn each time you push the "真空開" (Vacuum Compartment) button. The lamp and operating sound inform the operation mode. [Pg.38](#)

Caution

- Some foods are not suited to be stored, and some foods/containers require attention when storing them. [Pg.39](#)
- Juicy foods may be frozen when the ambient temperature is low.

When opening/closing the door of the Vacuum Compartment

Be sure to open the left/right door of the Refrigerator Compartment.

When opening the door

Hold the door handle on the bottom with your hand.

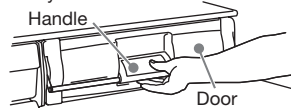

Lift the handle to release the lock.



When the hissing sound stops, pull the handle towards you to open.

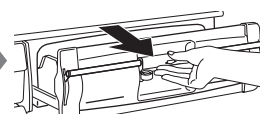

Notice

- The door can not be opened when the hissing sound can still be heard.

When closing the door

Push in until the end while holding the handle.

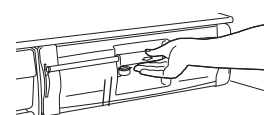
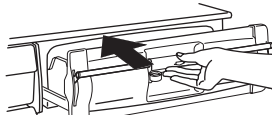

Fully press down the handle to lock the door.

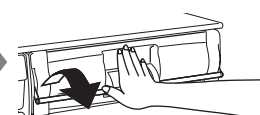

Notice

- Hold down the handle to the end. Or the Vacuum function will not work properly.
- If the handle is heavy, use the palm to hold it down.

Caution

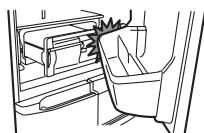

- Close and lock the door of the Vacuum Compartment before closing the door of the Refrigerator Compartment. If the door of the Refrigerator Compartment is closed with the door of the Vacuum Compartment opened, the double pocket, the Vacuum Compartment or foods may be damaged.

Notice

- If “真空開 -1°C” (Vacuum Compartment Subzero) / “真空開 +1°C” (Vacuum Compartment Chiller) indicator lamps flash, the vacuum function may not be in the normal conditions.  Pg.55



- The vacuum function will not work properly if some package of foods is pinched in or dirt/dust is adhered to the vacuum packing or the vacuum release valve (in blue).

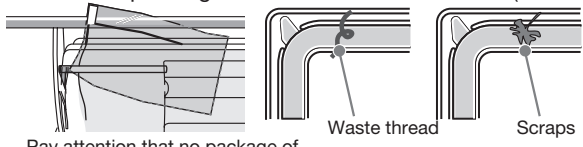

Pay attention that no package of the foods is pinched.

Waste thread

Scraps

- The vacuum function will not work properly if the vacuum packing or the vacuum release valve (in blue) comes off or is loosened.

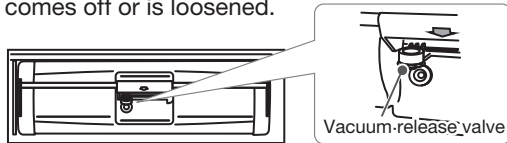



Vacuum-release valve

- Moisture in juicy foods stored in the Vacuum Compartment will evaporate and cause dew condensation or frost in the Vacuum Compartment. If water drops and/or frost adheres inside the Vacuum Compartment or around the door of the Vacuum Compartment, wipe off them with a dry cloth.

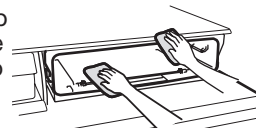

- Make sure to wipe off spilled water or food soup soon, if any. Water will be frozen, which may lead to a trouble of the Vacuum Case (with the door).



- For troubleshooting about the Vacuum Compartment, see “Troubleshooting”  Pg.55
- Replace an old vacuum packing if the vacuum state can't be kept well.  Pg.57

How to maintain/care the Vacuum Compartment

Be sure to remove foods contained in the Vacuum Compartment.

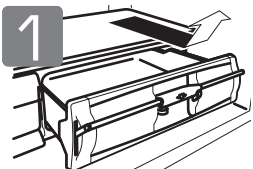

Pull the door, lift up the edge of the Vacuum Case (with the door) lightly and then pull it out.



Wipe the vacuum packing, the inside the Vacuum Case and the packing support, using a soft cloth wet by lukewarm water.

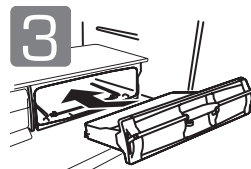
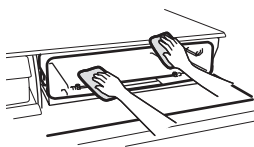

Put the Vacuum Case (with the door) back into the Vacuum Container, and then lower the lock of the handle.

How to maintain/care the Vacuum Compartment with the vacuum packing removed

Remove the Vacuum Case (with the door) first. Remove the door of the Vacuum Compartment and the vacuum packing in the following way, and then maintain/care them. Do not remove other things except the door of the Vacuum Case and the vacuum packing.

How to remove the door of the Vacuum Case

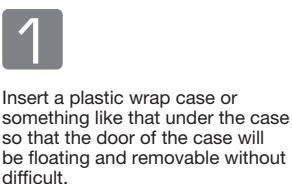

Insert a plastic wrap case or something like that under the case so that the door of the case will be floating and removable without difficult.



Unset the tab at the edge of the Vacuum Case.

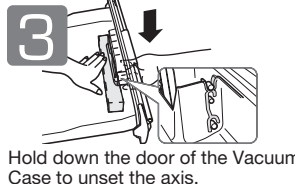

Hold down the door of the Vacuum Case to unset the axis.

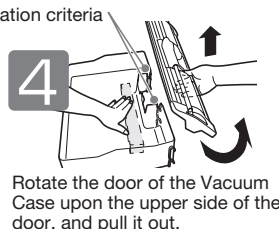

Rotate the door of the Vacuum Case upon the upper side of the door, and pull it out.

How to maintain/care the vacuum packing

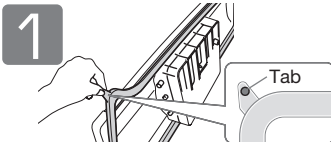

Grasp the tab of the vacuum packing on the observer's upper right and remove it by hand carefully.

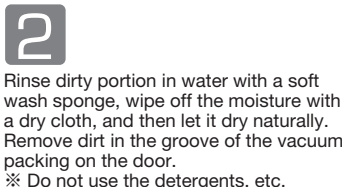

Rinse dirty portion in water with a soft wash sponge, wipe off the moisture with a dry cloth, and then let it dry naturally. Remove dirt in the groove of the vacuum packing on the door.
※ Do not use the detergents, etc.

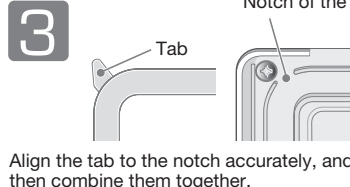

Align the tab to the notch accurately, and then combine them together.

How to install the door of the Vacuum Case

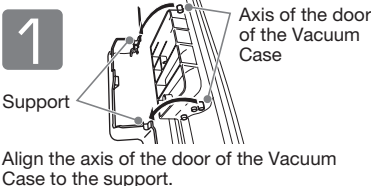

Align the axis of the door of the Vacuum Case to the support.

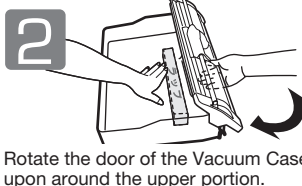

Rotate the door of the Vacuum Case upon around the upper portion.

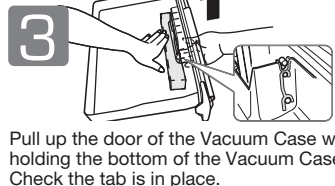

Pull up the door of the Vacuum Case while holding the bottom of the Vacuum Case. Check the tab is in place.

Caution

- Do not rinse the door of the Vacuum Case in water.
- If detergents and others except lukewarm water are used to clean the vacuum packing, the vacuum packing may be damaged, deformed or change in color, which may cause that the vacuum state can't be kept well.
- Loosened vacuum packing or loose-fitting door of the Vacuum Case may cause that the vacuum state can't be kept well.

FREEZER COMPARTMENT

Upper Freezer

- With Quick Freezing System, all the moisture, natural nutrients and good flavor in the foods are preserved in an instant.  Pg.45
- It is recommended to use this compartment when freezing meat and/or fish quickly.

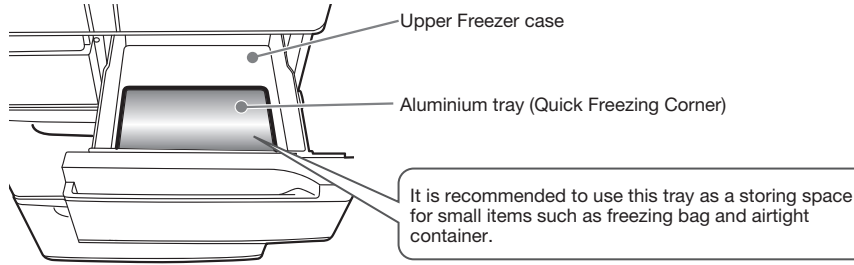

Lower Freezer

- 3-layer freezer case provides you with large storage space compartment and convenient reach of your freeze food items. It is suitable for storing the foods preserved for a long time and the foods that melt easily such as ice cream.

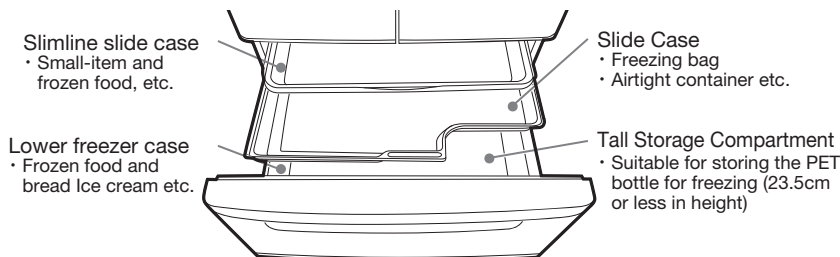

- Moving the aluminium tray in the Upper Freezer to the left side of the Slimline slide case, it can be used as the Quick Freezing Corner.

How to use the Ice Compartment (Automatic ice maker)

 Pg.46

Height of the storageable food

- Store foods of which height are suited for each case.
- Otherwise, the door will not be closed securely, which lead to inefficient cooling action. In addition, it may cause damage of foods or each case.
- Keep the food off from the bottom of the slimline case and/or the slide case.

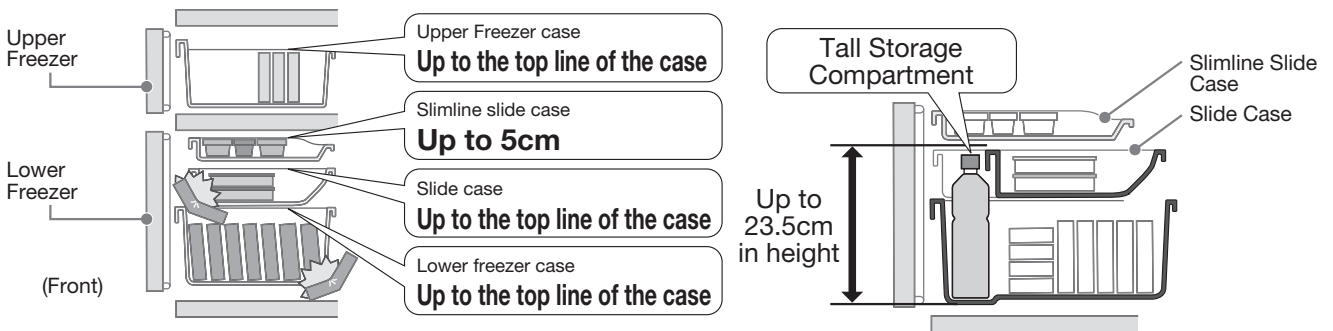

- Do not store any 500ml PET bottle in the Slimline slide case. It cannot be taken out because it expands when it is frozen.
- Do not use with the Slimline slide case and/or Slide case removed.
- Food may be caught in and/or drop to the inner part of the case, and as a result, the door may not close completely.
- When storing tall food in the Tall Compartment, make sure that it does not contact with the Slimline Slide Case and/or the Slide Case.
- Store only food which can be frozen, such as PET bottle only for freezing.

Adjust the temperature of the freezer compartment

Control Panel on the Refrigerator Compartment Door

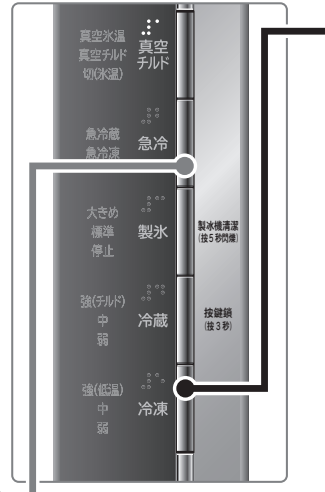

Adjust the temperature of the freezer compartment

Push the “冷凍” button to adjust the temperature of the freezer compartment.

The temperatures are standard values under the specific condition (the surrounding temperature of 30°C, no food stored, door closed and the temperature in the refrigerator is steady).

強 (低温)	About -23 ~ -20°C (Low temperature freezing)
中	About -20 ~ -18°C
弱	About -18 ~ -15°C

- Select "中" in ordinary usage. The temperature may change depending on the operation states.
- Temperatures in the Quick Freezing operation are lower than the temperatures described in the left.
- If operating the refrigerator for a long time with the "強 (低温)" selected, ice cream etc. may become hard or it may take a longer time to thaw food.

Notice

- The displayed character will disappear about 2 minutes after the operation finishes. However, “急冷” (Quick Cooling) and “eco” operation indicator lamps will not be turned off. (Pg.38)
- For more information about the panel for operation. (Pg.38)
- To adjust the temperature more finely. (Pg.57)

Quick Freezing

1 Place the food wrapped with plastic film on the aluminium tray in the upper Freezer.

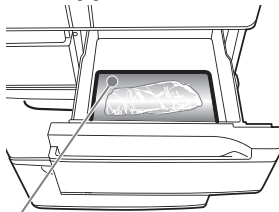

Quick Freezing Corner

2 Push the “急冷” button. ※

Light ON pushing the button



※ Indicator lamps other than “急冷凍” (Quick Freezing) will be turned off about 2 minutes after “急冷凍” (Quick Freezing) is set.

3 "Quick Freezing operation" will end automatically in about 90 minutes.

Light OFF



Push the “急冷” button again if you want to stop the operation.

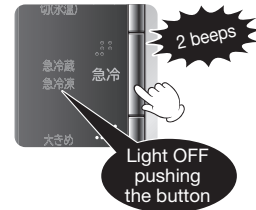

- Freezing compartment is cooled preferentially in the "Quick Freezing operation". For that reason, temperature of the Refrigerator Compartment may rise if opening/closing the Refrigerator Compartment door frequently.
- Warm food such as rice can be easily frozen by this function. Make sure that you never burn yourself when putting hot food in. It is recommended to put it in after it is cooled down to 50 ~ 60°C.
- Pushing the “急冷凍” button again within 60 minutes after the end of the "Quick Freezing (Quick Ice Making)" operation, the lamp is illuminated, but the operation does not start. The operation will start after 60 minutes pass.
- Make sure to wrap the food with plastic film to prevent it from sticking on the aluminium tray.
- Thinly subdividing food, not only can they freeze completely soon, but also they can be taken out easily.

Troubleshooting

When this happens

Please check. This is the cause.

Freezer does not cool well enough, frost and/or dew occur, ice cream becomes soft

- Did you open the door frequently?
 - It is recommended to open and close the door quickly and/or minimize the number of times of opening and closing the door.
- Does any food or package caught in the door prevent the door from closing completely?
 - Check that there is not any space between the door seal and its contact surface with the door closed.
- Is food squeezed in? or Is a large amount of food put in at a time?
 - Make sure that any food does not protrude beyond the storage height limit of each compartment, and do not store the amount of food that may prevent the door from opening and closing.
 - Allow clearance between each food in each compartment.
- Are Upper Freezer case and Slimline slide case installed correctly?
 - Install them correctly. (Pg.50)

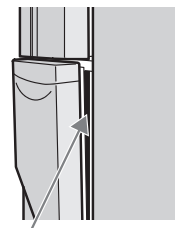

There is a space between the door seal and its contact surface.

Caution

- If opening and closing the door frequently, temperature of food may become higher and food such as ice cream may become soft.

ICE COMPARTMENT (AUTOMATIC ICE MAKER)

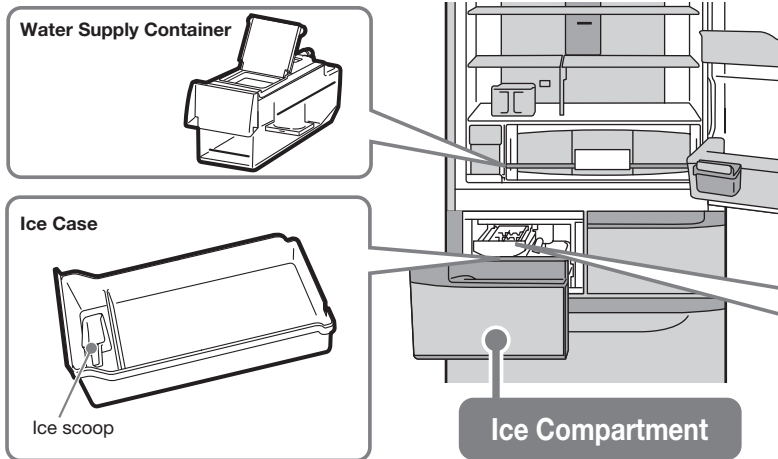

Control Panel for operation

Button for switching between Ice Size and Stop Ice Making



AUTOMATIC ICE MAKER

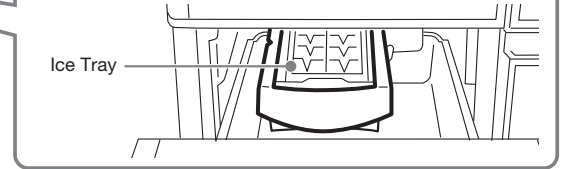

How to make Ice

1 Setting of the Automatic ice maker

Push the “製氷” (Ice Making) button to select the ice size. Pg.47

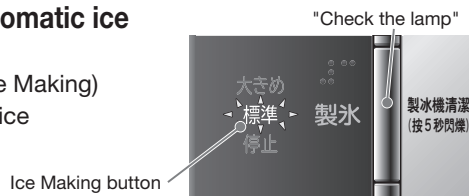

2 Take off the Water Supply Container.

Add water if water level reaches to the “Add water line”.

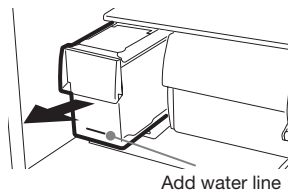

3 Open the lid and add water.

Add water until water level reaches to the “Container-full line”.

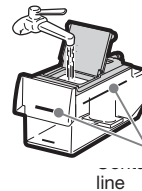

4 Replace the Water Supply Container.

Push it beyond the “Container set position” line.

※ Water may spill out if the water supply container is inclined. Wipe off spilled water immediately.

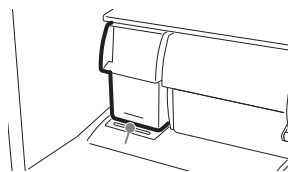

Perform “製氷機清潔” (Ice Maker Cleaning) when making ice for the first time or for the first time in a week or more. Pg.51

5 Ice making starts automatically and ice is stored in the Ice case.

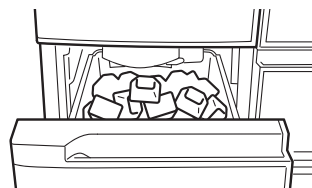

Notice

It may take 24 hours or more to make ice for the first time. 8 ices are usually made per 2 ~ 3 hours.

Caution

- We recommend * “portable tap water.”
*: please check & verify with local authority.
- Change water and clean the container at least once a week for hygiene purposes.
- If the ice made of mineral water containing a lot of mineral ingredients is put into water, white powder may come out, however this is those mineral ingredients and harmless.

- Furthermore, these types of water are easily contaminated with bacteria. Please wash the container usually once 3 days.



Mineral water
(Hardness: 100mg/L or less)



Water purified by water purifier



Well water
(Required to satisfy the appropriate water quality standard)

- Do not use the following ones because they may cause malfunction, deformation or stucked ice.



Juice drink



Sports drink



Carbonated drink



Tea



Warning

- Do not put your hand in the mechanical part of the Automatic ice maker.

- You may be injured when the ice tray turns.

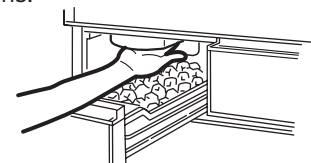

How to change the Settings of the Automatic ice maker

When making ice with the Automatic ice maker

Making normal ice
Push the “製氷” button to display “Normal”.

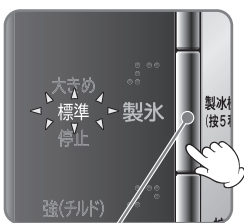

Ice Making button

Making large ice
Push the “製氷” button to display “Large”.



Stop making ice

Push the “製氷” button to display “Stop”. Automatic Ice Maker stops and does not make ice.

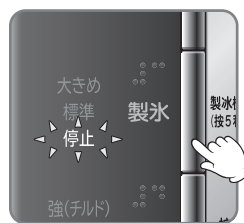

When you want to make ice quickly (Quick Ice Making)

Push the Quick Cooling button to display “Quick Freezing”. Quick Ice Making operation starts and ice making time reduces. (Pg.45)

※ It returns to the normal operation mode in about 90 minutes.

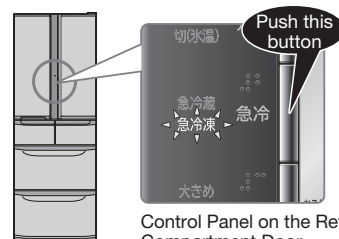

Control Panel on the Refrigerator Compartment Door

Notice

- The displayed character will disappear about 2 minutes after the operation finishes. However, “急冷” (Quick Cooling) and “eco” operation indicator lamps will not be turned off.
- Every time you push the “製氷” button, operation mode changes in order of “Make normal ice” → “Make large ice” → “Stop Ice Making”. The lamp and operating sound inform the operation mode.
- The lamp may flash when switching the operation mode to “Stop Ice Making”, but it is turned off automatically in about 20 seconds. (It is not a malfunction)
- After stopping ice making, wash the water supply container thoroughly and replace it after it dries. In particular, dry the water filter thoroughly. (How to maintain (Pg.51))
- Stopping ice making, operation sound of automatic ice making (occurred during ice separating and water supply etc.) can be stopped.

Ice making time and capacity

Required time for an ice making operation (8 pcs by once)

Ice size	Normal	Large
Operation mode		
Normal operation	About 110 minutes ~ 140 minutes	About 150 minutes ~ 170 minutes
Quick Ice Making	About 70 minutes ~ 90 minutes	About 90 minutes ~ 110 minutes

Storage amount of the Ice case

Ice size	Normal	Large
Mode		
Normal state	About 90 pcs	About 60 pcs
Stored ice cubes are levelled to the front part of the case	About 150 pcs	About 120 pcs

● It takes a long time to make ice under the following conditions.

- When using for the first time (It may take more than 24 hours)
- After opening/closing the door frequently
- After storing a large amount of food at a time
- After power failure
- When the ambient temperature is low under certain conditions (ex: using in winter)
- After maintaining the Ice Tray

Notice

- Amount of stored ice is automatically detected by the stored ice amount detecting lever of the Automatic ice maker which cannot be seen usually. Automatic ice maker stops making ice when the amount of the stored ice reaches to the specified level and it restarts making ice when the amount is below the level.
 - Limit line of stored ice amount represents the guide line of stored ice amount when the Automatic ice maker makes ice with ice levelled.
- If the ice is stored partially, the detecting lever may contact the ice early. As a result, the Automatic ice maker may stop making ice before the amount of stored ice is enough.

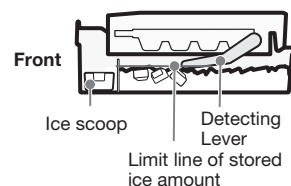

Caution

- Do not store any food such as frozen food other than ice in the Ice case when making ice automatically. (Otherwise, it may not make ice, or the door may not open or parts may damage because the food interferes with the parts of the Automatic ice maker.)

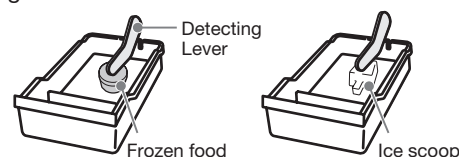

Is any frozen food stored in the inner part of the Ice case?

Is the ice scoop in the inner part of the Ice case?

VEGETABLE COMPARTMENT

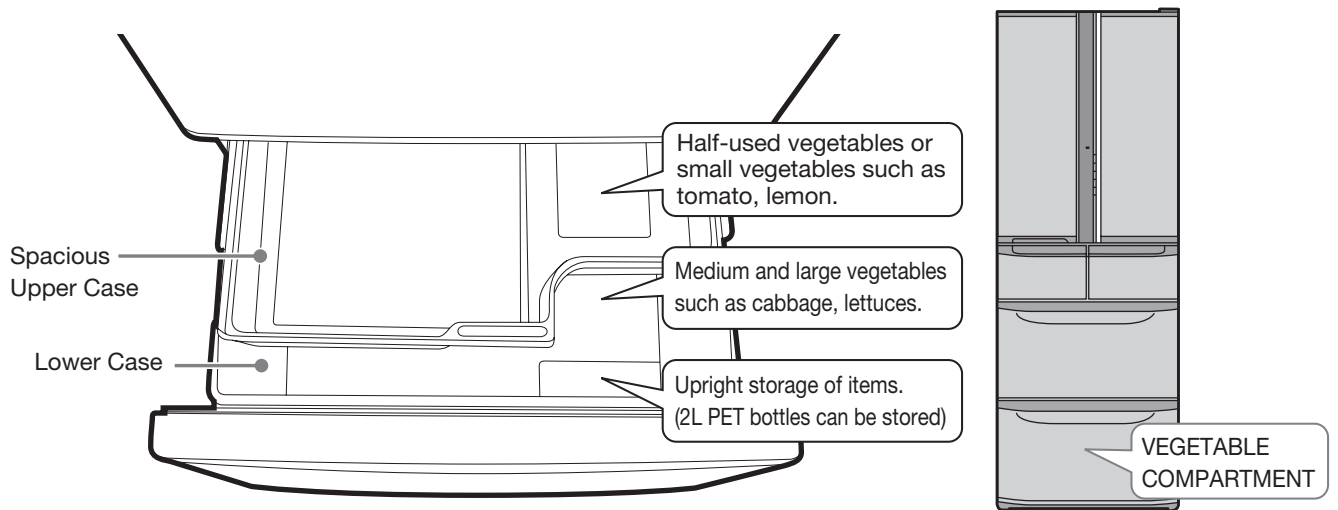

Lower Case/Spacious Upper Case

Stored vegetables are not exposed to cold air directly, and they are cooled gently but thoroughly. All vegetables stay crisp, vibrant and fresh with their own moisture without wrapping with plastic film.

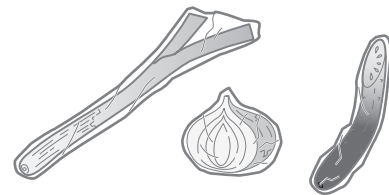
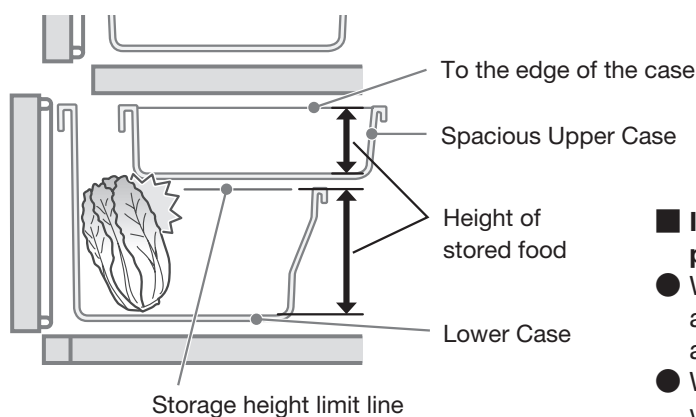

- It is recommended to wrap vegetable with plastic film when the following conditions exist.
- When it is undesirable that the stored foods absorb the smells of the stored vegetables such as scallion, leeks, and shallots
- When storing the vegetables and/or fruits which were used partially
- When the amount of the stored vegetables is small or many wrapped vegetables are stored
- When it is undesirable that dew occurs in the Vegetable Compartment

Caution

- Make sure that any stored food does not protrude beyond the storage height limit line.
 - Otherwise, the door may not close completely, and as a result, the refrigerator may not cool sufficiently.
 - Food and/or each case may damage.
- Some kind of PET bottle may not be able to be stored. Moreover, PET bottle may not be able to be stored if its cap is not completely tightened.
- Temperature in this compartment may become lower when the surrounding temperature is low.
- Dew may adhere to the spacious upper case or the ceiling in the Vegetable Compartment, depending on the volume/type of vegetables, because the humidity is high in the Vegetable Compartment. Water is no good to perishable foods. Wipe off water with a dry cloth.

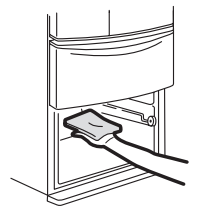

Notice

- Open/close the Vegetable Compartment Door slowly. Opening/closing the door mightily, the foods stored in the tall storage compartment (PET bottle etc.) may overturn.

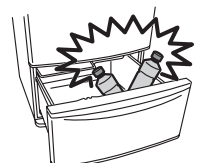

HOW TO MAINTAIN/HOW TO CARE THE INNER - OUTER OF THE REFRIGERATOR

When dirt is found

- Wipe off it immediately.
It is recommended to clean the hidden places once a year.
- Wipe off it using a soft cloth wet by lukewarm water. If it is hard to clean dirt, wipe off it using diluted neutral detergent for kitchen and a soft cloth wet by lukewarm water.
Some detergents cannot be used for this purpose. Therefore, refer to the **Caution** on this page.
- Take foods out beforehand if you remove the parts.

Caution

- Do not wipe out the movable contact surface of the rail for cases and drawers because the lubricant agent is applied to it. (The lubricant agent complies with the Food Sanitation Law.)

Power Plug

- If the dust on the power plug remains not cleaned, it may cause a fire. Clean it once a year.

- 1 Unplug the power cord from the outlet.
- 2 Check the following matters.
 - Is any damage found on the power cord?
 - Does the power plug become hot?
- 3 Remove the dust and wipe it with a dry cloth.

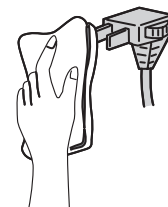

- 4 Connect the power plug firmly to a power outlet.

How to care the inner - outer of the refrigerator



Warning

Make sure to unplug the power plug when maintaining the refrigerator.

Control Panel for operation

- Wipe the Control Panel for operation with a soft dry cloth.
- Make sure that water never splash to it. Otherwise, it may cause malfunction.



Surface of door

- Wipe the surface of door using a soft cloth wet by lukewarm water.
- Wipe the door in stainless color along the hairline on the surface.

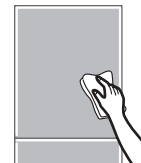

Door gaskets

- Wipe it thoroughly because it can become easily dirty.

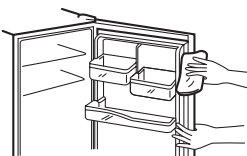

Liquid receivers

- Wipe off them if liquid collects and/or they becomes dirty.

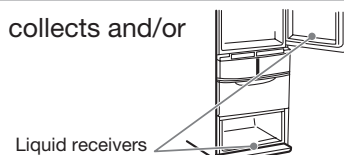

The back/floor of the refrigerator

1 Pull the leg cover and remove it.

Push it in from the front when installing it.

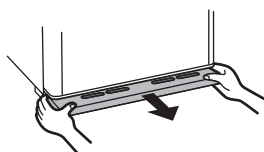

2 Float the Adjustable mounts from the floor and draw the refrigerator straight.

Lay the protection board etc. on the floor which can be easily scratched.

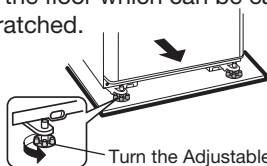

Turn the Adjustable mounts

3 Wipe off dirt on the back of the refrigerator, wall and floor.

The back of the refrigerator easily becomes dirty because fine dust is accumulated on it by convection of air.

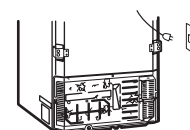

Caution It may cause damage and discoloration of the door, paintwork and plastic parts.

- Do not use the following ones.
 - Alkaline and alkalescence detergent for kitchen, plate powder, powder soap, oil, hot water, scrubbing brush, acid, benzine, thinner, alcohol, and bleach, etc. (check the "liquid" part of "display according to the household goods quality labeling law" for detergent.)
- Make sure to wipe off spilled cooking oil, citrus fruits juice and food soup.
- When using a chemical dustcloth, follow the instructions of it.

HOW TO REMOVE PARTS

Vacuum Case with the door

- Pull the door, lift the case at the edge of it lightly, and then pull it out. For more information.

 Pg.42, 43

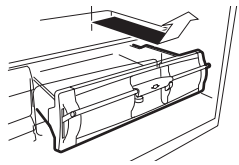

Door pocket

- Lift up the door pocket while tapping the left/right of its bottom surface, and remove it.

Insert the door pocket fully to the end when installing it

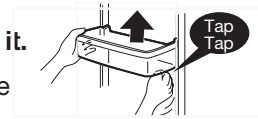

Fixed shelf

- Draw the shelf, and pull off the two pins on the lower right and remove it.

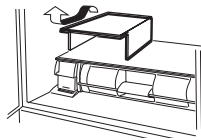

Reversible shelf

- Slightly lift up and pull out.

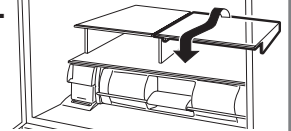

Height adjustable shelf · Lower shelf

- 1 Slightly lift up the back of the shelf and draw it.

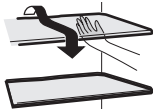

- 2 Raise the shelf as shown in figure, and turn it and remove it.

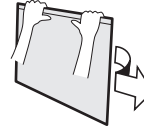
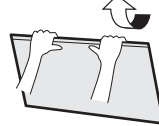

When installing the shelf, slide it until it reaches to the interior wall, then slightly lift up the back of the shelf and push it in. (hitch the forks of the shelf to the parts on the back of the shelf)

Caution Door may damage if drawing the shelf without turning it.

Ice Compartment/ Upper Freezer

- Draw the door fully and lift up the case towards you.

Put the case bottom on the frame and set the case.

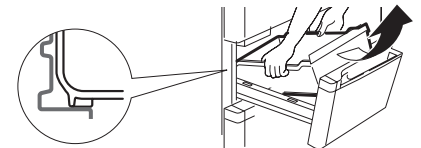

Lower Freezer

- 1 Draw the door fully, and draw the Slimline slide case and the Slide case respectively.

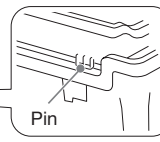

When installing it, insert the pins on the left/right of the Lower freezer case into the square holes on the frame to install it. Moreover, hitch the pins on the left/right of the Slide case to the outside of the Lower freezer case.

- 2 Lift up the Lower freezer case.

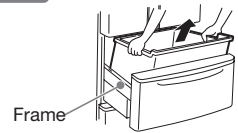

Vegetable Compartment

- 1 Draw the door fully and pull up the Spacious vegetable case as shown in the figure.

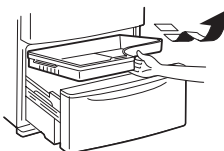

- 2 Lift up the front part of the door, and draw it further and incline it.

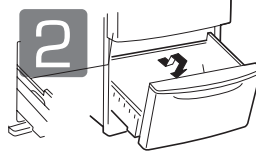

- 3 Lift up the Vegetable Case. When installing it, insert the pins on the left/right inner sides of the Vegetable Case into the square holes on the frame, and put the edge of the Vegetable Case on the frame to install it.



How to install the slide door

Ice Compartment/Upper Freezer

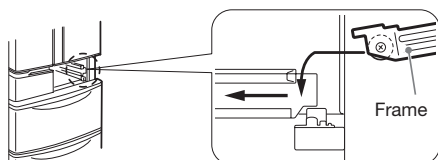

Vegetable Compartment/Lower Freezer

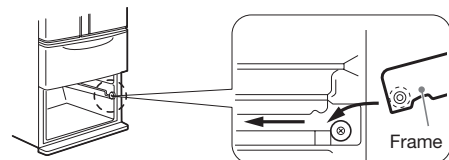

HOW TO MAINTAIN THE AUTOMATIC ICE MAKER

Ice Maker Cleaning

- When using for the first time
- When not used for more than one week

Ice tray and water supply line can be washed.
Be sure to check the followings before starting the operation.

● Water supply container

- Water is filled in it.
- The container is set properly as specified.

● Ice case

- If there remains ice, remove it.

Go to the next step after checking them.

1 Push the “製冰” button and hold it for more than 5 seconds after closing all the doors and turning on the display.

Release the button when “大顆” / “標準” / “停止” indicator lamps flash and the buzzer sounds. “Ice Maker Cleaning” will start.

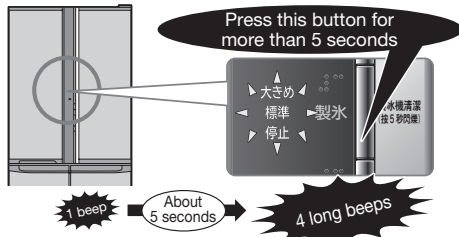

- The indicator lamp will flash and the buzzer will sound for about 3 minutes.
- “製冰機清潔” (Ice Maker Cleaning) can't be interrupted.
- Opening any door of the refrigerator during the Ice Maker Cleaning may cause malfunction. Do not open/close any door until “Ice Maker Cleaning” finishes.
- Alarm will sound even after stopping the Door Alarm.

2 The buzzer will stop and the indicator lamp will be turned off in about 3 minutes. After that, remove water in the Ice case and wipe the case.

Make sure that water does not spill out when removing the case.

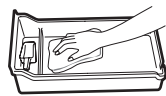

There is no problem with using water remaining in the water supply container, if any.

Water supply container

● Recommended maintenance intervals

Tap water	Once a week
Mineral water, well water, water purified by water purifier, cooled boiled water, etc. (water which doesn't contain chlorine)	Once three days

Water which doesn't contain chlorine may easily cause slime and/ or fur compared with tap water. Wash the Water Supply Container regularly to prevent bacteria from breeding when such water is used.

● Remove the seal from the lid and wash it with a soft wash sponge.

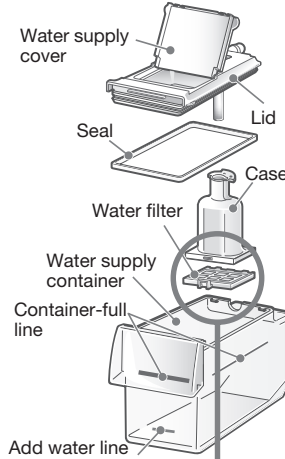

● How to open the lid

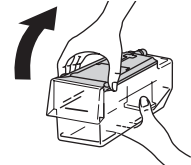

● How to close the lid

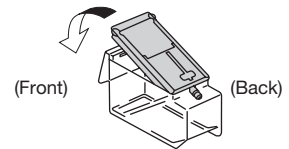

Insert the lid from its rear side and close it in the direction of the arrow.

Water filter

(Replace it normally every 3 ~ 4 years.) Pg.57

1 Turn the case and remove it from the lid.

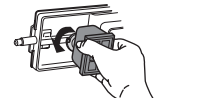

2 Pull the tab of the water filter with fingers and remove it from the case.



3 Wash it with a soft wash sponge etc.

Do not use the detergents etc.

- Notice**
- Wash the water supply container thoroughly and replace it after drying it if you stop ice making and you are not to use the Automatic ice maker for a while.
 - In particular, dry the water filter thoroughly.

Ice tray ● Maintain it once a year

1 Push the “製冰” button to stop supplying water to the ice tray and turn on the “停止” indicator lamp. (Stop ice making)

※ If the indicator lamp flashes, perform the following operation after the “停止” lamp is turned on in 20 seconds.



2 Open the Ice Compartment Door.

- 1 Pull down the lever and 2 draw the frame.
- 3 Raise the cover (▲ part) in the direction of the arrow.
- 4 Remove the ice tray from the frame.

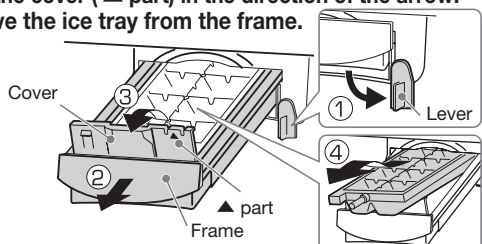

Notice

- If you cannot push the frame of the ice tray into the end, the ice tray drive motor may have operated. Remove the ice tray once and push the frame in, and wait 1 minute after closing the Ice Compartment Door. Preparation for the ice tray drive motor finishes, and you can set the ice tray.

3 Empty the ice tray and wash it lightly in the stream.

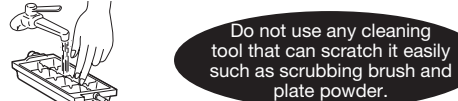

Do not use any cleaning tool that can scratch it easily such as scrubbing brush and plate powder.

- 1 Set the ice tray and 2 close the cover.
- 3 Make the frame horizontal and push it into the end, and
- 4 Pull up the lever.

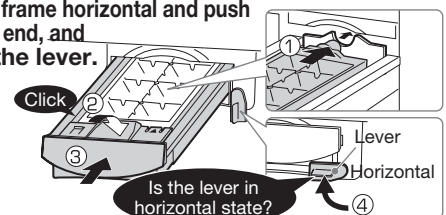

5 Push the “製冰” button to turn on the indicator lamp. (Automatic Ice Making starts)



TROUBLESHOOTING

Check the following points before asking repair. Contact your dealer or our customer center if the problem still exists after checking them.

FAQ when using for the first time

Refrigerator does not cool well enough or make ice when using for the first time

- It takes time to cool in summer or when a lot of foods are stored.
 - It may take more than 4 ~ 24 hours to cool fully immediately after installing.
- When using for the first time, it takes time to make ice because ice making starts after cooling fully.
 - It may take more than 24 hours to make ice according to the amount of food and the way of packing it.
 - Open/close the door quickly and/or minimize the number of times of opening and closing the door.
 - Allow clearance between each food in each compartment.

When this happens

Please check. This is the cause.



Control Panel does not respond.

Control Panel does not respond.

- Is "Button Lock" selected by using the lock function on the panel for operation?  Pg.58
- Is Refrigerator Compartment Door open? Operate after closing it.

Automatic ice making is not properly performed.

Ice cannot be made at all.

- Is the "停止" lamp on the control panel in the Refrigerator Compartment turned off?  Pg.47
- Is the water supply container pushed in beyond the "Container set position"?  Pg.46
- Is anything other than ice stored in the Ice case?  Pg.47

It takes a long time to make ice. There is no ice in the ice tray.

- Do you open the door frequently or store a large amount of food at a time?
 - Refrigerator may not cool fully.
 - Minimize the number of times of opening and closing the door until it cools fully.
 - Allow clearance as much as possible between each stored food.
- It may take more than 4 hours to make ice in winter.
- Immediately after turning on the "製冰" lamp, it may take longer than usual to make ice.
- Does any food or package caught in the door prevent the door from closing completely?
 - Check that there is not any space between the door seal and its contact surface when the door is closed.

Projection is generated on ice.

- It is frozen water collected in the ice tray groove. It does not indicate any trouble.

Stored ice rounds. Ice sticks together.

- Ice naturally becomes small or sticks mutually if ice is stored for a long term.
- Do you open the door frequently or store a large amount of food at a time? As a result, temperature in the refrigerator rises and stored ice becomes small or sticks together.
- The door or the drawer compartment may not temporarily have been closed completely.

Small ice is made.

- Small ice may be made if only a small amount of water remains in the water supply container.
 - Add water until water level reaches to the "Container-full line" of the water supply container.  Pg.46

Ice stuck together is made.

- Ice stuck together may be made if the amount of water supplied to the ice tray is not even.
 - Add water until water level reaches to the "Container-full line" of the water supply container.  Pg.46
- If the ice tray is damaged, ice may not be easily separated from the ice tray and ice stuck together may be made. If same trouble occurs many times, consult your dealer and replace the ice tray.

There is white impurity in ice.

- It is because the fine air bubble in water is contained in ice.
 - It does not indicate any trouble.
- Did you use mineral water to make ice?
 - Mineral contained in water may freeze and become white impurity in ice. It may remain after thawing in water, but it is harmless.

Ice tray frame cannot be drawn

- Is "大顆" or "標準" display of "製冰" turned on?
 - Ice tray frame cannot be drawn while making ice with the Automatic ice maker. Turn off the "製冰" lamp.
 - If the lamp starts flashing, wait 20 seconds until the lamp is turned off and draw the frame after that.  Pg.51

When this happens

Please check. This is the cause.

Refrigerator does not cool

Refrigerator does not cool.
Frost and/or dew occur.
Ice cream becomes soft.

Check the storage state of food

- Does any food or package caught in the door prevent the door from closing completely?
→ Check that there is not any space between the door seal and its contact surface when the door is closed.
- Is food squeezed in? or Is a large amount of food put in at a time?
→ Make sure that any food does not protrude beyond the storage height limit of each compartment, and do not store the amount of food that may prevent the door from opening and closing.
→ Allow clearance between each food in each compartment.
- Are Upper Freezer case and Slimline slide case installed correctly?
→ Install them correctly. [Pg.50](#)

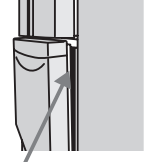

There is a space between the door seal and its contact surface.

Check the installation state

- Refrigerator may not fully cool according to the installation place, the clearance around it and the surrounding conditions.
Check whether it has been installed correctly. [Pg.36](#)

Check the temperature setting

- Refrigerator may not cool fully when the temperature setting is "弱". [Pg.40, 45](#)
→ Switch the temperature setting of the compartment where it does not fully cool to "中" or "強".
- Does the temperature around the refrigerator become high due to a seasonal factor (ex: using in summer)?
→ Switch the temperature setting of the compartment where it does not fully cool to "強".

Check the usage of the refrigerator

- Temperature in the refrigerator rises little by little while its door is open. If opening/closing the door frequently or leaving the door open for a long time, temperature cannot easily lower.
→ Reduce the number of times of opening and closing the door or open/close the door quickly.

Frost and/or dew occur

Frost and/or dew adhere to the refrigerator interior or the frame of the drawer compartment.

- The door or the drawer compartment may not temporarily have been closed completely.
→ Check whether the drawer compartment or the door has been closed completely after closing them.
- The door may be opened/closed frequently or door may have remained open for a long time.
→ Reduce the number of times of opening and closing the door or open/close the door quickly.
- Lowering the level of the defrost heater, dew may be adhered to the rotation partition part when humidity is high. [Pg.57](#)

Dew adheres to the outside of the refrigerator (exterior, door seal, door and drawer compartment etc).

- Dew may adhere to the those parts when the indoor humidity is high (ex: rainy day).
- Frost and/or dew may adhere to the refrigerator interior or the door frame when the warm outside air comes in contact with those parts.
→ Wipe off with a dry cloth.

Dew condensation occurs in the Refrigerator Compartment

- Dew may adhere to the wall and/or frost may adhere around the outlet of the cooling air of the aluminum panel when the number of opening/closing the door is large or humidity around the refrigerator is high.
→ Wipe off them with a dry cloth.

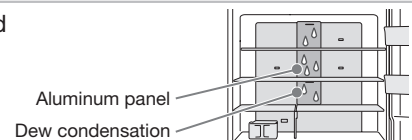

Dew condensation occurs in the Vegetable Compartment

- The humidity in the Vegetable Compartment is higher than other compartments. (To prevent vegetables from drying and to make them last longer)
→ If it is undesirable that dew adheres to the stored vegetables, wrap them with the plastic film.
- Water may drop into cases placed in the Vegetable Compartment due to dew concentration.
→ Wipe off them with a dry cloth.

Refrigerator cools overly

Refrigerator cools overly
Foods freeze









- "強" is selected in the temperature setting. → Switch it to "中". [Pg.40, 45](#)
- The surrounding temperature is lower than 5°C. → Switch the temperature setting to "弱". [Pg.40, 45](#)
- Do not place any food in front of the cold air blowout port.

TROUBLESHOOTING

When this happens

Please check. This is the cause.

Abnormal operating sound is generated

Annoying sound is generated by the refrigerator.	● Refrigerator may not be installed properly.												
	<table border="1"> <thead> <tr> <th>Possible Cause</th> <th>Possible Solution</th> </tr> </thead> <tbody> <tr> <td>Floor bends</td> <td>Lay the firm board on the floor and install the refrigerator on it.  Pg.36</td> </tr> <tr> <td>Refrigerator comes in contact with the wall or furniture, etc.</td> <td>Allow clearance around the refrigerator and install it.</td> </tr> <tr> <td>Leg cover comes off</td> <td>Install it firmly.  Pg.36</td> </tr> </tbody> </table>	Possible Cause	Possible Solution	Floor bends	Lay the firm board on the floor and install the refrigerator on it.  Pg.36	Refrigerator comes in contact with the wall or furniture, etc.	Allow clearance around the refrigerator and install it.	Leg cover comes off	Install it firmly.  Pg.36				
	Possible Cause	Possible Solution											
	Floor bends	Lay the firm board on the floor and install the refrigerator on it.  Pg.36											
Refrigerator comes in contact with the wall or furniture, etc.	Allow clearance around the refrigerator and install it.												
Leg cover comes off	Install it firmly.  Pg.36												
● You may feel that the operation sound is large because the compressor operates in high-speed under the following conditions: the refrigerator does not cool fully on the occasion such as using it for the first time, opening/closing the door frequently, the surrounding temperature is high. → The sound becomes small after cooling fully.													
Operation sound lasts long	● It is because the compressor operates in low-speed for conserving energy.												
Operation sound sometimes becomes larger	● It is because the system changes the operating power of the refrigerator according to the temperature change.												
When other sound such as shown in the right table is generated by the refrigerator	● The following sounds are generated when the refrigerator is operating normally, so they do not indicate any trouble.												
	<table border="1"> <thead> <tr> <th>Type of sound</th> <th>Source of sound</th> </tr> </thead> <tbody> <tr> <td> <ul style="list-style-type: none"> • Sound like water flowing (trickling) • Sound like collision (tapping) • Sound like water boiling (bubbling up) • Sound like meat roasting (sizzling) </td> <td>These sounds are caused when the refrigerant to cool the refrigerator flows or water flows/evaporates to remove frost.</td> </tr> <tr> <td> <ul style="list-style-type: none"> • Sound like squeaking (cracking) </td> <td>This sound is caused because the parts squeaks when the refrigerator temperature changes.</td> </tr> <tr> <td> <ul style="list-style-type: none"> • Sound like something is caught (clacking) • Sound like roaring (honking) • Sound caused immediately after closing the door (booming) </td> <td>These sounds are caused when the electric parts to control the refrigerator temperature operates.</td> </tr> <tr> <td> <ul style="list-style-type: none"> • Sounds caused by the Automatic ice maker (zooming) (rattling) (clunking) </td> <td>These sounds are caused when ice separates from the ice tray of the Automatic ice maker or ice is supplied to the ice tray. These sounds also occur every 2 hours if the water supply container is empty. If you turn off the “停止” lamp, ice making stops and the sound does not occur.  Pg.47</td> </tr> <tr> <td> <ul style="list-style-type: none"> • Sound occurred sometimes (clacking) </td> <td>This sound is caused when the refrigerator starts the operation to cool.</td> </tr> </tbody> </table>	Type of sound	Source of sound	<ul style="list-style-type: none"> • Sound like water flowing (trickling) • Sound like collision (tapping) • Sound like water boiling (bubbling up) • Sound like meat roasting (sizzling) 	These sounds are caused when the refrigerant to cool the refrigerator flows or water flows/evaporates to remove frost.	<ul style="list-style-type: none"> • Sound like squeaking (cracking) 	This sound is caused because the parts squeaks when the refrigerator temperature changes.	<ul style="list-style-type: none"> • Sound like something is caught (clacking) • Sound like roaring (honking) • Sound caused immediately after closing the door (booming) 	These sounds are caused when the electric parts to control the refrigerator temperature operates.	<ul style="list-style-type: none"> • Sounds caused by the Automatic ice maker (zooming) (rattling) (clunking) 	These sounds are caused when ice separates from the ice tray of the Automatic ice maker or ice is supplied to the ice tray. These sounds also occur every 2 hours if the water supply container is empty. If you turn off the “停止” lamp, ice making stops and the sound does not occur.  Pg.47	<ul style="list-style-type: none"> • Sound occurred sometimes (clacking) 	This sound is caused when the refrigerator starts the operation to cool.
	Type of sound	Source of sound											
	<ul style="list-style-type: none"> • Sound like water flowing (trickling) • Sound like collision (tapping) • Sound like water boiling (bubbling up) • Sound like meat roasting (sizzling) 	These sounds are caused when the refrigerant to cool the refrigerator flows or water flows/evaporates to remove frost.											
	<ul style="list-style-type: none"> • Sound like squeaking (cracking) 	This sound is caused because the parts squeaks when the refrigerator temperature changes.											
	<ul style="list-style-type: none"> • Sound like something is caught (clacking) • Sound like roaring (honking) • Sound caused immediately after closing the door (booming) 	These sounds are caused when the electric parts to control the refrigerator temperature operates.											
<ul style="list-style-type: none"> • Sounds caused by the Automatic ice maker (zooming) (rattling) (clunking) 	These sounds are caused when ice separates from the ice tray of the Automatic ice maker or ice is supplied to the ice tray. These sounds also occur every 2 hours if the water supply container is empty. If you turn off the “停止” lamp, ice making stops and the sound does not occur.  Pg.47												
<ul style="list-style-type: none"> • Sound occurred sometimes (clacking) 	This sound is caused when the refrigerator starts the operation to cool.												

The refrigerator becomes hot

The side of the refrigerator becomes hot Hot air comes from the bottom of the refrigerator	<p>● Hot air may come from the bottom of the refrigerator to exhaust the heat generated when the cooling device operates. → The temperature may reach 50 ~ 60°C immediately after installation or in summer, but there is no problem with the safety and the performance.</p>
---	---

When this happens

Please check. This is the cause.

There is something strange with the Vacuum Compartment

When “真空開 +1°C” (Vacuum Compartment Chiller) or “真空開 -1°C” (Vacuum Compartment Subzero) the indicator lamp blinks



The vacuum function may not be operating normally. Check the followings:

- Is the handle held down to the end and locked?
→ The vacuum function will not work unless it is locked.
- Is a food package or a hair caught in the vacuum packing and the support?
→ A small piece of debris may prevent the vacuum function from operating. Remove it.
- Does the vacuum packing/the support get dirty?
→ Wipe off them if it is dirty. (Pg.42, 43)
- Is the vacuum release valve (in blue) in place or loosened?
→ Attach it to the hole on the handle securely.

Hissing sound does not occur when opening.



- Are any food package etc. caught in the Vacuum Packing? or Are there any dirt, waste thread or scraps on it? (Pg.42, 43)
→ If a food package is caught in the Vacuum packing, remove it.
→ Clean the dirty Vacuum Packing.
- Are the Vacuum Packing and/or the Vacuum Releasing Valve (blue colored) located on the bottom of the handle installed firmly? or Are they loose?
- Is "Vacuum Compartment Chiller" or "Vacuum Compartment Subzero" display turned on?
- Is the handle pulled up?
- Hissing sound may not occur immediately after opening/closing the Vacuum Compartment because the vacuum pump enters the preparation state for starting the operation, but it does not indicate any trouble.

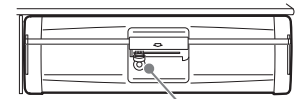
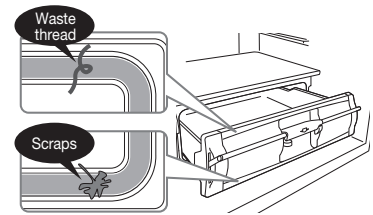

Vacuum Releasing Valve

It is not clear whether the Vacuum Compartment has been vacuumized.

- The Vacuum Compartment has been vacuumized properly if a vacuum releasing sound (hissing sound) occurs when opening it.

The handle cannot be locked.

- Are any food etc. caught in the inner part of the Vacuum Compartment Case or the Vacuum Packing? (Pg.42, 43)
- Are the rotation axes in the front part of the Vacuum Compartment Case and the door installed firmly? (Pg.42, 43)

Booming sound and vibration occur around the Vacuum Compartment.

- This sound is caused when the vacuum pump operates. It does not indicate any trouble.
- You can stop the vacuum pump operation when you want to stop the sound (ex: nighttime).
- If the sound and the vibration occur frequently, something may be caught in the door or there may be a dirt on the Vacuum Packing. (Pg.42, 43)

Drop of water or frost occurs in the Vacuum Compartment.

- The moisture from the juicy foods may cause dew condensation and/or frost adhering insider the compartment because the Vacuum Compartment is sealed.
→ It is recommended to wrap the juicy foods with plastic film, etc.
→ Wipe off water and/or frost with a dry cloth.

Food in the Vacuum Compartment freezes

- Is any vegetable sensitive to low temperature such as eggplant and cucumber stored? (Pg.39)
- Is the setting "Vacuum Compartment Subzero" or "OFF" selected? (Pg.42)

TROUBLESHOOTING

When this happens

Please check. This is the cause.

It smells strange

Ice smells	<ul style="list-style-type: none"> ● Do the water supply container and/or water filter become dirty? or Does ice become old? → Wash them once a week to prevent "slime" and/or "fur". (Pg.51) ● Chlorine may strongly smell because chlorine in tap water is condensed.
It smells in the refrigerator	<ul style="list-style-type: none"> ● Is any food which strongly smells stored without any wrapping? → This does not affect the refrigerator performance. Adjust the refrigerator adjustable mount to keep it level if you want to correct it. (Pg.34) ● Seal that kind of food with plastic film etc. to store it.
It smells like plastic	<ul style="list-style-type: none"> ● This smell occurs because a lot of plastic parts are used in the refrigerator, but the smell decreases gradually while cooling. Keep the room ventilated.

Door is not in a horizontal state

Door is not in a horizontal state	<ul style="list-style-type: none"> ● Installation place may not be horizontal. Left side or right side of the door may be slightly lower when the left or right leg is sunk in the floor surface because of the soft floor material and the addition of food weight. → This does not affect the refrigerator performance. Adjust the refrigerator adjustable mount to keep it level if you want to correct it. (Pg.34) → Lay the firm board which has more than 1cm thickness on the floor if the refrigerator itself inclines.
More force is required to open the door immediately after closing the door.	<ul style="list-style-type: none"> ● It is because air entered the Refrigerator Compartment is rapidly cooled and the pressure in the Refrigerator Compartment temporarily lowers.
Another door opens after closing one door.	<ul style="list-style-type: none"> ● Another door may open for a moment by the wind pressure because cool air path connects each compartment.

Others

You feel electricity a little when touching the main body of the refrigerator	<ul style="list-style-type: none"> ● The refrigerator may be charged with static electricity, but there is no problem with the safety. → It is recommended to ground if you want to remove it. (Pg.37)
Radio and/or television are disturbed by noises	<ul style="list-style-type: none"> ● It is caused by the electromagnetic radiation slightly generated from this refrigerator. → Install the refrigerator on a place far away from the television, radio and interphone etc. → It is recommended to connect the power plug to the power outlet separated from the antenna terminal and ground the refrigerator. (Pg.37)
There are thin lines like scratches on the plastic parts	<ul style="list-style-type: none"> ● Those lines are caused by the liquid resin flowing when plastic is molded. They are especially conspicuous for the transparent parts, but there is no problem with the strength and they can never lead to any cracks.
There are waving and/or distortions on the door surface, the side and the top surface of the refrigerator.	<ul style="list-style-type: none"> ● Slight waving and/or distortions are generated in the manufacturing process of the refrigerator. They may be conspicuous according to the position of the light source and/or the brightness etc., but there is no problem with the performance.
The Control Panel for operation is not illuminated	<ul style="list-style-type: none"> ● The displayed character will disappear about 2 minutes after the operation finishes. However, “急冷” (Quick Cooling) or “eco” operation indicator lamp will not be turned off. Push either button to turn it on.
There is a small hole inside the door	<ul style="list-style-type: none"> ● This hole is used to escape the air inside when filling the heat insulation material into the door during the production process. It is neither a flaw nor abnormal thing.

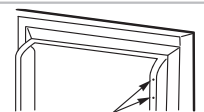

Hole (inside of the door)

PRACTICAL ADVICE ON HOW TO USE THE REFRIGERATOR/REPLACEMENT PARTS

The "Check" display flashes on the Control Panel for operation



- This flashing shows that there is a problem with the Automatic Ice Maker, the temperature control device or the frost removal device etc.
- Consult your dealer if the flashing does not stop even after checking the point listed in the following table.

	Flashing pattern	Possible Cause	Check Point
Check	"Check" flashing 3 times	Food etc. may come in contact with the ice tray or the stored ice amount detection lever.	Empty the Ice Compartment and perform "Cleaning the Ice Making".
	"Check" flashing (excluding flashing 3 times)	This flashing shows that there is a problem.	Consult your dealer.
Vacuum	"Vacuum Compartment Subzero" or "Vacuum Compartment Chiller" flashing	The vacuum function may not work properly. It may be in the operation check mode for serviceman. (※ 1)	Check the points described in "There is something strange with the Vacuum Compartment" on P.55. It will return to the normal mode after about 10 minutes. There is no problem with using.
	"Large" "Normal" "Stop" Flashing	It is in process of Ice Maker Cleaning.	Check the points described in "How to maintain the Automatic Ice Maker" on P.51.
Ice making function	"Stop" flashing	It will flash if you stop ice making during the ice making process.	Check the points described in "Ice Tray" on P.51.
	All displays flashing	Door remains open for more than 1 minute. (ex: door is not completely closed.)	Check the points described in "Door Alarm" on P.58.

※ 1 Pushing the button long (more than 10 seconds), the refrigerator may go into the operation check mode.

The electric supply failed

- Reduce the number of times of opening and closing the door and avoid storing food additionally until the electric supply is restored.

The refrigerator is not expected to use for a long term

- Unplug the power plug and maintain the inner of the refrigerator and the Automatic Ice Maker, and leave all the door open to dry the refrigerator for 2 ~ 3 days. (参照 Pg.49~51)

Remove frost

- Any operation to remove frost is not required because this refrigerator remove frost automatically. Thawed water is collected in the evaporating tray and automatically evaporates.

When you want to adjust the temperature more finely

You can adjust "MIN"/"MID"/"MAX" more finely when setting the temperature in the Refrigerator Compartment and the Freezer Compartment.

1. Open the Lower Freezer Door.
2. Push the Quick Cooling button on the control panel on the refrigerator door for more than 5 seconds until single long beep sounds.
3. Push the Cooling button or the Freezing button to adjust the temperature. The temperature becomes lower by 1 step every time you push the button. (If you push the button when "MAX" is selected, the setting returns to "MIN".)
4. If you want to stop the fine adjustment, perform the operation of 1 and 2. Two beeps sound and You can set the temperature by normal step.

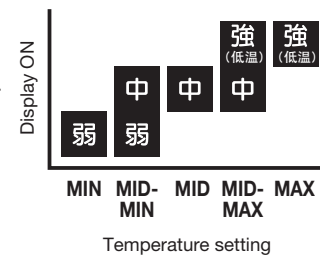

REPLACEMENT PARTS

When replacing the following parts, make sure to tell your dealer the type name and buy the special parts.

Replacing the water filter

- Replace the water filter when it becomes old. (Replace it normally once 3 ~ 4 years.)
- Ordering the replacement water filter
Tell your dealer the parts number: RJK-30 to buy the replacement water filter. (Ice making capacity is the same with a water filter removed.)

Replacement of the vacuum packing

- Replace it if it is damaged.
- Order information about replacement parts

Type	Parts number
Type: R-S51AMJ	R-S50AM 321

["eco" OPERATION INDICATOR LAMP]/DOOR ALARM/LOCK FUNCTION OF THE PANEL FOR OPERATION

["eco" Operation indicator lamp]

RECYCLE



Indicates the operation mode of the refrigerator automatically. This will be illuminated while it is operating with low electric power consumption such as Frost Recycle Cooling and others.

["eco" operation indicator lamp] can be turned off when you feel uneasy at night, etc.

How to turn off the indicator lamp

Push the "真空開 +1°C" (Vacuum Compartment Chiller) for about "3 seconds" until the "eco" indicator lamp starts to flash.

"eco" operation indicator lamp is turned off and the setting is completed.

Notice

- If "eco" indicator lamp isn't illuminated, check the following things.
 - Is the "eco" operation indicator lamp set as Off? → Perform the above-mentioned procedure for how to return.
 - It will not be illuminated just after purchasing the refrigerator, or when so many foods are stored or when the number of opening/closing the door is large, because the compressor needs to operate on high speed. → Open/close the door quickly or minimize the number of opening/closing the door.
 - When the quick cooling functions ("急冷凍" (Quick Freezing), "急冷蔵" (Quick Cooling)) work, it will be illuminated after the quick cooling functions finish and the operation of the refrigerator gets stable.
- When connecting/disconnecting the power plug or after recovering from electric power failure, it will return to the setting where the "eco" operation indicator lamp is illuminated.



How to return

Push the "真空開 +1°C" (Vacuum Compartment Chiller) for about "3 seconds" until the "eco" indicator lamp is illuminated.

"eco" operation indicator lamp will be turned on or off, depending on the current operation mode.



Door Alarm

If the door remains open for more than 1 minute, the alarm sounds as shown in the table below and the LED lamp on the Control Panel flashes.

Duration when door is open	Alarm sound	Control Panel on the Refrigerator Compartment Door
1 minute	3 long beeps	Flashing
2 minutes	5 long beeps	Flashing
Longer than 3 minutes	It keeps continuously sounding.	Flashing

The Door Alarm is available for the Refrigerator Compartment, Ice Compartment and Lower Freezer. (It is not available for the Upper Freezer and Vegetable Compartment.)

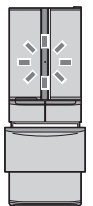

The Door Alarm can be stopped.

When you want to stop the alarm

Push the "急冷凍" button and hold it for about 3 seconds until "2 beeps" sound.

The displays will be returned to the original state when Alarm stops.

Notice

- The flashing of the character displayed on the Control Panel for operation will be stopped where the Door Alarm is stopped. The buzzer does not sound, too.
- The Door Alarm is set as On at the time of installation.
- When connecting/disconnecting the power plug or after recovering from electric power failure, it will return to the setting where the Door Alarm sounds.

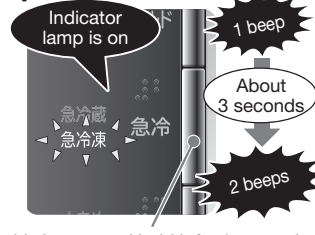

When you want to sound the alarm again

Push the "急冷凍" button and hold it for about 3 seconds until "2 beeps" sound.

The displays will be returned to the original state when the setting is completed.

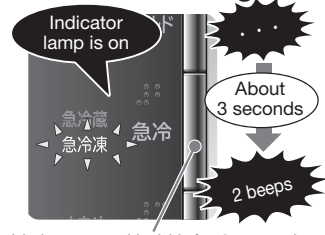

How to set the Lock function of the panel for operation

When this indicator lamp (Lock on the panel for operation) is illuminated, any other button will not be actuated by pushing it. This function prevents the wrong operation or mischief of a small child.

Continue to push the "冷蔵" (Cooling) button for 3 seconds and more until it beeps twice, and then you can select "設定" (Setting) or "解除" (Release) of the Lock function on the panel for operation.

Notice

- Check the temperature setting of the Refrigerator Compartment after the setting finishes.

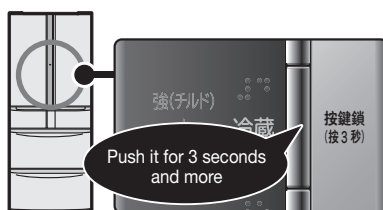

When setting the Lock as On on the panel for operation



Turn on this display.

When releasing the Lock function on the panel for operation



Turn off this display.

有關碳氫化合物的冰箱 / 規格 / 可容納的食品重量

ABOUT NON-CFC REFRIGERATORS/SPECIFICATION/STORABLE WEIGHT

有關碳氫化合物的冰箱 About non-CFC refrigerators

- 本冰箱所使用冷媒及其他斷熱材料皆無使用氟氯化碳 而是使用碳氫化合物。碳氫化合物不會破壞地球臭氧層、對地球溫室效應的影響非常小、屬於環保物質。
- 碳氫化合物為可燃型物質。冷媒密封於冷媒迴路管中、在一般的使用情況下應該不會發生外洩的可能。但萬一有冷媒管線損壞的情況發生、請遠離火源及避免使用電器用品、將門窗打開以利空氣流通。之後、請立即與經銷商或日立技術中心聯絡。
- Instead of CFCs, hydrocarbons are used in the coolants and insulation materials used in this refrigerator. Hydrocarbons donot damage the ozone layer, and they are environmental-friendly materials, having an exceptionally small affect on global warming.
- CFC coolants are in ammable. The coolants are sealed in the coolant circuitry, and with normal operation they will not leak, but should the circuitry be damaged, refrain from using ames or other electrical products, and open windows for ventilation. After that, please contact the retail store or the repair department.

規格 SPECIFICATION

型號	Model	R-S51AMJ	
種類	Type	冷凍冷藏箱 Refrigerator-Freezer	
總有效內容積	Total Volume	501 ℓ	
外型尺寸	Dimentions	寬 W (mm)	620
		高 H (mm)	1818
		深 D (mm)	733
額定電壓 / 額定頻率	Rated Voltage / Frequency	110V/60Hz	
電動機額定消耗電功率	Rated Moter Input	80W	
除霜輸入功率	Rated Heater Input	130W	
消耗電量	Energy Consumption	28kWh/ 月	
能源因數值	Energy Factor	22.2 ℓ /kWh/ 月	
冷媒種類 / 充填量	Refrigerant	R600a/84g	
總重量 (淨重)	Net Weight	96kg	
脫臭裝置	Deodrive	●	
自動製冰機	Automatic Ice Maker	●	
快速冷藏	Quick Cooling	●	
急速冷凍	Quick Freezing	●	
急速製冰	Quick Ice Making	●	
箱門警報器	Door Alarm	●	

可容納的食品重量 Storable weight

可容納於層架或收納盒內的食物重量如下：

The following table shows the weight of food that can be stored on the shelves and in the cases.

	零件名稱	Name of parts	R-S51AMJ
冷藏室 Refrigerator compartment	可調式層架	Height adjustable shelf	16.0kg
	翻轉式層架・固定層架	Reversible shelf・Fixed shelf	16.0kg
	真空室上方的層架	Upper shelf of the vacuum compartment	5.0kg
	真空室盒	Vacuum compartment case	3.5kg
	置蛋架	Multiuse Egg Case	2.0kg
	軟管式容器站立架	Tube Stand	1.3kg
製冰室 Ice compartment	製冰盒	Ice case	請勿存放不是本自動製冰機製成的冰塊。 (P.19) Do not store any ice cubes other than the ones made by the automatic ice maker. (Pg.47)
上層冷凍室 Upper freezer	上層冷凍盒	Upper Freezer case	4.0kg
下層冷凍室 Lower freezer	薄滑動盒	Slimline slide case	4.0kg
	滑動盒	Slide case	6.5kg
	下層冷凍盒	Lower freezer case	11.5kg
蔬果保鮮室 Vegetable compartment	寬廣上段置物盒	Spacious Upper Case	6.5kg
	下段置物盒	Lower Case	13.0kg

日立家電技術中心一覽表

大台北技術中心	TEL：(02) 2771-8200
花蓮技術中心	TEL：(03) 852-9400
中壢技術中心	TEL：(03) 491-2219
台中技術中心	TEL：(04) 2220-1133
嘉義技術中心	TEL：(05) 236-1943
台南技術中心	TEL：(06) 260-6939
高雄技術中心	TEL：(07) 522-9100

日立家電（台灣）股份有限公司

台北市南京東路三段65號2樓 電話：(02) 2516-0500
日立家電網站：www.hsct.com.tw